

GARMIN[®]

zūmo[®] 395



Owner's Manual

© 2016 Garmin Ltd. or its subsidiaries

All rights reserved. Under the copyright laws, this manual may not be copied, in whole or in part, without the written consent of Garmin. Garmin reserves the right to change or improve its products and to make changes in the content of this manual without obligation to notify any person or organization of such changes or improvements. Go to www.garmin.com for current updates and supplemental information concerning the use of this product.

ANT[®], ANT+[®], Garmin[®], the Garmin logo, TracBack[®], VIRB[®], and zūmo[®] are trademarks of Garmin Ltd. or its subsidiaries, registered in the USA and other countries. myGarmin[™] and myTrends[™] are trademarks of Garmin Ltd. or its subsidiaries. These trademarks may not be used without the express permission of Garmin.

The Bluetooth[®] word mark and logos are owned by the Bluetooth SIG, Inc., and any use of such marks by Garmin is under license. microSD[™] is a trademark of SD-3C. Windows[®] is a registered trademark of Microsoft Corporation in the United States and/or other countries. Mac[®] is a trademark of Apple Computer, Inc. PANDORA[®], the Pandora logo, and the Pandora trade dress are trademarks or registered trademarks of Pandora Media, Inc. Used with permission. SPOTIFY[®] and the Spotify logo are among the registered trademarks of Spotify AB. Compatible mobile digital devices and premium subscription required, where available. Go to www.garmin.com. This product incorporates Spotify software which is subject to third party licenses found here: www.spotify.com/connect/third-party-licenses. Soundtrack every journey with Spotify. Play songs and artists you love, or let Spotify entertain you.

This product is ANT+[®] certified. Visit www.thisisant.com/directory for a list of compatible products and apps.

Table of Contents

Installation	1	Resetting the Fuel Tank Mileage	8
Mounting Your Device in a Motorcycle.....	1	Enabling Dynamic Fuel Stops.....	8
Powered Motorcycle Mount.....	1	Finding and Saving Locations	8
Installing the Handlebar Base.....	1	Finding a Location Using the Search Bar.....	9
Attaching the Power Cables to the Motorcycle Mount.....	1	Viewing Search Results on the Map.....	9
Attaching the Base Plate to the Motorcycle Mount.....	2	Changing the Search Area.....	9
Attaching the Base Plate to the Handlebar Base.....	2	Points of Interest.....	9
Installing Your Device in the Motorcycle Mount.....	2	Finding a Location by Category.....	9
Removing Your Device from the Motorcycle Mount.....	2	Searching Within a Category.....	9
Mounting Your Device in an Automobile.....	2	Navigating to Points of Interest Within a Venue.....	9
Getting Started	2	Foursquare.....	9
Device Overview.....	3	Search Tools.....	9
Product Updates.....	3	Finding an Address.....	9
Updating Maps and Software with Garmin Express.....	3	Finding an Intersection.....	10
Turning the Device On or Off.....	3	Finding a City.....	10
Acquiring GPS Signals.....	3	Finding a Location Using Coordinates.....	10
Status Bar Icons.....	3	Viewing Recently Found Locations.....	10
Using the On-Screen Buttons.....	4	Clearing the List of Recently Found Locations.....	10
Adjusting the Volume.....	4	Finding Your Last Parking Spot.....	10
Adjusting the Screen Brightness.....	4	Viewing Current Location Information.....	10
Transportation Modes.....	4	Finding Emergency Services and Fuel.....	10
Choosing a Transportation Mode.....	4	Getting Directions to Your Current Location.....	10
Using the On-Screen Keyboard.....	4	Adding a Shortcut.....	10
Using the Large Button Keyboard.....	4	Removing a Shortcut.....	10
Rider Awareness Features and Alerts	4	Saving Locations.....	10
Enabling or Disabling Rider Alerts.....	4	Saving a Location.....	10
Red Light and Speed Cameras.....	4	Saving Your Current Location.....	10
Viewing Helmet Law Notifications.....	4	Editing a Saved Location.....	10
Searching for Helmet Laws.....	5	Assigning Categories to a Saved Location.....	10
Navigating to Your Destination	5	Deleting a Saved Location.....	11
Routes.....	5	Sharing a Saved Location.....	11
Starting a Route.....	5	Using the Map	11
Changing the Route Calculation Mode.....	5	Map Tools.....	11
Taking a Route Using Adventurous Routing.....	5	Viewing a Map Tool.....	11
Creating a Round-Trip Route.....	5	Enabling Map Tools.....	11
Starting a Route by Using the Map.....	5	Up Ahead.....	11
Going Home.....	5	Viewing Upcoming Locations.....	11
Your Route on the Map.....	5	Customizing the Up Ahead Categories.....	11
Active Lane Guidance.....	6	Trip Information.....	11
Viewing Turns and Directions.....	6	Viewing Trip Data from the Map.....	11
Viewing the Entire Route on the Map.....	6	Viewing the Trip Information Page.....	12
Adding a Location to Your Route.....	6	Viewing the Trip Log.....	12
Shaping Your Route.....	6	Resetting Trip Information.....	12
Taking a Detour.....	6	Customizing the Map.....	12
Stopping the Route.....	6	Customizing the Map Layers.....	12
Trip Planner.....	6	Changing the Map Data Field.....	12
Planning a Trip.....	7	Changing the Map Perspective.....	12
Navigating to a Saved Trip.....	7	Bluetooth Connected Features	12
Optimizing the Order of Destinations in a Trip.....	7	Bluetooth Feature Requirements.....	12
Editing and Reordering Locations in a Trip.....	7	Pairing Your Phone and Headset.....	12
Changing Routing Options for a Trip.....	7	Bluetooth Feature Status Icons.....	12
Scheduling a Trip.....	7	Enabling or Disabling Bluetooth Features for Your Headset.....	12
Sharing Trips.....	7	Hands-Free Calling.....	12
Using Suggested Routes.....	7	Placing a Call.....	12
Avoiding Delays, Tolls, and Areas.....	7	Receiving a Call.....	13
Avoiding Toll Roads.....	7	Using the Call History.....	13
Avoiding Toll Stickers.....	8	Using In-Call Options.....	13
Avoiding Road Features.....	8	Saving a Home Phone Number.....	13
Custom Avoidances.....	8	Disconnecting a Bluetooth Device.....	13
Navigating Off Road.....	8	Deleting a Paired Phone.....	13
Fuel Tracking.....	8	Using the Apps	13
Enabling Fuel Tracking.....	8	Media Player.....	13
Setting a Low Fuel Warning.....	8	Adding the Media Player Tool to the Map.....	13
		Changing the Media Source.....	13
		Tracks.....	13

Viewing Track Information	13	Installing a Memory Card for Maps and Data	18
TracBack®	13	Data Management	18
Following Your Recent Track	13	About Memory Cards	18
Saving Your Recent Track as a Trip	13	Connecting the Device to Your Computer	18
Tire Pressure	14	Transferring Data From Your Computer	18
Setting Up the Tire Pressure Sensors	14	Viewing GPS Signal Status	19
Installing the Sensors on Your Tires	14	Purchasing Additional Maps	19
Tire Pressure Alerts	14	Purchasing Accessories	19
Tire Pressure Sensor Sleep Mode	14	Index	20
Using the Compass	14		
VIRB® Remote	15		
Controlling a VIRB Action Camera	15		
Logging Service History	15		
Adding Service Categories	15		
Deleting Service Categories	15		
Renaming Service Categories	15		
Deleting Service Records	15		
Editing a Service Record	15		
Viewing Help Files	15		
Searching Help Topics	15		
Viewing Previous Routes and Destinations	15		
Customizing the Device	15		
Map and Vehicle Settings	15		
Enabling or Disabling Rider Alerts	15		
Enabling Maps	15		
Navigation Settings	15		
Calculation Mode Settings	16		
Setting a Simulated Location	16		
Bluetooth Settings	16		
Disabling Bluetooth	16		
Display Settings	16		
Units and Time Settings	16		
Setting the Time	16		
Language and Keyboard Settings	16		
Proximity Alerts Settings	16		
Device and Privacy Settings	16		
Restoring Settings	16		
Device Information	17		
Specifications	17		
Charging the Device	17		
Device Maintenance	17		
Device Care	17		
Cleaning the Outer Casing	17		
Cleaning the Touchscreen	17		
Avoiding Theft	17		
Resetting the Device	17		
Removing the Device, Mount, and Suction Cup	17		
Removing the Device from the Mount	17		
Removing the Mount from the Suction Cup	17		
Removing the Suction Cup from the Windshield	17		
Changing the Fuse in the Vehicle Power Cable	17		
Troubleshooting	17		
The suction cup will not stay on my windshield	17		
My device is not acquiring satellite signals	18		
The device does not charge in my vehicle	18		
My battery does not stay charged for very long	18		
My device does not appear as a removable drive on my computer	18		
My device does not appear as a portable device on my computer	18		
My device does not appear as either a portable device or a removable drive or volume on my computer	18		
My phone will not connect to the device	18		
Appendix	18		

Installation

Mounting Your Device in a Motorcycle

Powered Motorcycle Mount

⚠ WARNING

Garmin® strongly recommends having an experienced installer with the proper knowledge of electrical systems install the device. Incorrectly wiring the power cable can result in damage to the vehicle or the battery and can cause bodily injury.

See the *Important Safety and Product Information* guide in the product box for product warnings and other important information.

The device must be mounted in a suitable and secure location on your motorcycle, based on available power sources and safe cable routing.

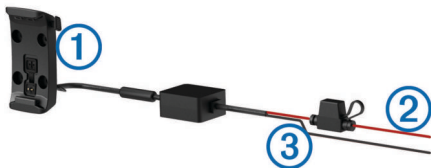

①	Motorcycle cradle
②	12 to 24 Vdc system power (red) with in-line fuse
③	System ground (black)

Installing the Handlebar Base

The device includes parts for two handlebar installation solutions. Custom mounts may require additional hardware.

Installing the U-bolt and Handlebar Base

- 1 Place the U-bolt ① around the handlebar ②, and thread the ends through the handlebar base ③.

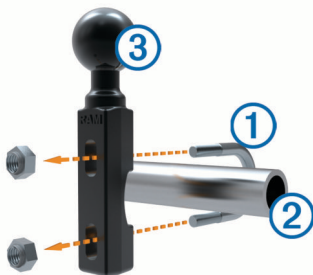

- 2 Tighten the nuts to secure the base.

NOTE: The recommended torque is 50 lbf-in (5.65 N-m). Do not exceed torque of 80 lbf-in (9.04 N-m).

Installing the Handlebar Base to the Clutch-Clamp or Brake-Clamp Brackets

- 1 Remove the two factory bolts on your clutch-clamp or brake-clamp bracket ①.

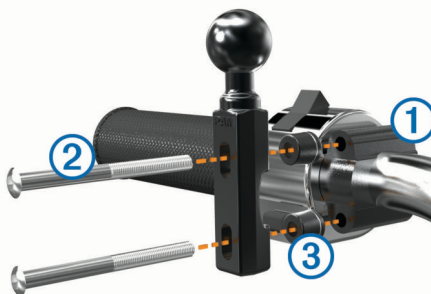

NOTE: Both 1/4 in. standard and M6 bolts are included. Match the size of the factory bolts on your clutch-clamp or brake-clamp bracket.

- 2 Thread the new bolts ② through the handlebar base, spacers ③, and clutch-clamp or brake-clamp bracket.
- 3 Tighten the bolts to secure the base.

Attaching the Power Cables to the Motorcycle Mount

- 1 Thread the power cable connector ① through the top of the opening in the motorcycle mount.



- 2 Slide the cable down to the bottom of the opening ② and pull the cable back until it is snug.
- 3 Screw the black screw ③ into the back of the mount ④ to hold the cable in place.

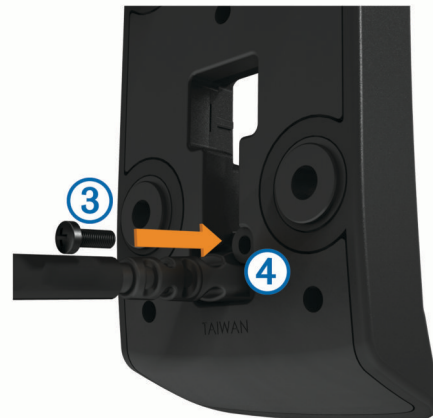

- 4 Thread the weather cap ⑤ through the top hole and press it into the hole.



Attaching the Base Plate to the Motorcycle Mount

NOTICE

Direct, sustained contact with the base plate, or any part of the motorcycle, may damage the mount over time. To prevent this kind of damage, you must place the mounting spacers between the mount and base plate, and make sure that no part of the device or mount touches the motorcycle.

- 1 Thread the M4 x 20 mm panhead screws ① through the washers ②, cradle, spacers ③, and base plate ④.

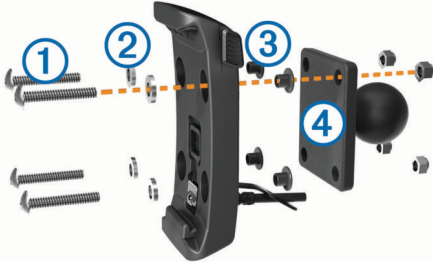

- 2 Tighten the nuts to secure the base plate.

Attaching the Base Plate to the Handlebar Base

- 1 Align the ball of the handlebar base ① and the ball of the base plate ② with each end of the double-socket arm ③.



- 2 Insert each ball into the double-socket arm.
- 3 Tighten the knob slightly.
- 4 Adjust for optimal viewing and operation.
- 5 Tighten the knob to secure the mount.

Installing Your Device in the Motorcycle Mount

- 1 Fit the bottom of your device into the cradle.



- 2 Tilt the device back until it snaps into place.
- 3 If the latch on top of the mount stays up after you insert the device, press it down.

Removing Your Device from the Motorcycle Mount

- 1 Press the release button on the side of the mount.
- 2 Lift out the device.

Mounting Your Device in an Automobile

NOTICE

Before mounting the device, check the local laws pertaining to windshield mounting.

WARNING

This product contains a lithium-ion battery. To prevent the possibility of personal injury or product damage caused by battery exposure to extreme heat, store the device out of direct sunlight.

Do not use the suction cup mount on a motorcycle.

See the *Important Safety and Product Information* guide in the product box for product warnings and other important information.

- 1 Plug the automotive power cable ① into the port ② on the mount.

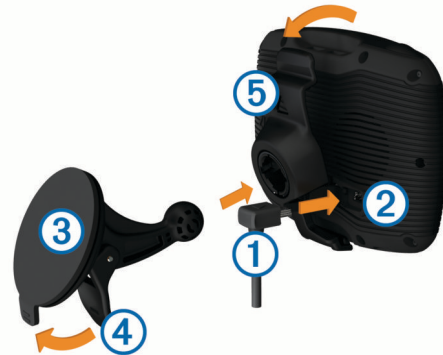

- 2 Remove the clear plastic from the suction cup ③.
- 3 Clean and dry your windshield and the suction cup with a lint-free cloth.
- 4 Press the suction cup to the windshield, and flip the lever ④ back toward the windshield.
- 5 Snap the cradle ⑤ onto the suction cup arm.
- 6 Fit the bottom of your device into the cradle.
- 7 Tilt the device back until it snaps into place.
- 8 Plug the other end of the automotive power cable into a power outlet.

Getting Started

WARNING

See the *Important Safety and Product Information* guide in the product box for product warnings and other important information.

- Update the maps and software on your device ([Product Updates](#), page 3).
- Mount the device and connect it to power ([Installation](#), page 1).
- Pair your Bluetooth® phone and headset ([Pairing Your Phone and Headset](#), page 12) (optional).
- Acquire GPS signals ([Acquiring GPS Signals](#), page 3).
- Adjust the screen brightness ([Adjusting the Screen Brightness](#), page 4).
- Navigate to your destination ([Starting a Route](#), page 5).

Device Overview



①	Power key
②	Micro-USB power and data port
③	Audio line-out jack
④	microSD™ memory card slot

Product Updates

On your computer, install Garmin Express™ (www.garmin.com/express).

This provides easy access to these services for Garmin devices:

- Software updates
- Map updates
- Product registration

Updating Maps and Software with Garmin Express

You can use the Garmin Express application to download and install the latest map and software updates for your device.

- 1 If you do not have the Garmin Express application installed on your computer, go to garmin.com/express and follow the on-screen instructions to install it.
- 2 Open the Garmin Express application.
- 3 Connect your device to your computer using a mini-USB cable.

The small end of the cable connects to the mini-USB port ① on your zūmo device, and the large end connects to an available USB port on your computer.



- 4 In the Garmin Express application, click **Add a Device**.
The Garmin Express application searches for your device and displays the device name and serial number.
- 5 Click **Add Device**, and follow the on-screen instructions to add your device to the Garmin Express application.
When setup is complete, the Garmin Express application displays the updates available for your device.

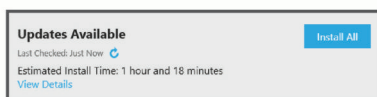

- 6 Select an option:
 - To install all available updates, click **Install All**.

- To install a specific update, click **View Details**, and click **Install** next to the update you want.

The Garmin Express application downloads and installs the updates onto your device. Map updates are very large, and this process may take a long time on slower internet connections.

NOTE: If a map update is too large for the internal storage of the device, the software may prompt you to install a microSD card in your device to add storage space (*Installing a Memory Card for Maps and Data*, page 18).

- 7 Follow the on-screen instructions during the update process to finish installing updates.
For example, during the update process, the Garmin Express application may instruct you to disconnect and reconnect your device.

Turning the Device On or Off

- To turn the device on, press the power key, or connect the device to power.
- To put the device in power saving mode, press the power key while the device is on.

While in power saving mode, the screen is off and the device uses very little power, but it can wake instantly for use.

TIP: You can charge your device faster by putting it in power saving mode while charging the battery.

- To turn off the device completely, hold the power key until a prompt appears on the screen, and select **Off**.

The prompt appears after five seconds. If you release the power key before the prompt appears, the device enters power saving mode.

Acquiring GPS Signals

When you turn on your navigation device, the GPS receiver must collect satellite data and establish the current location. in the status bar indicates the satellite signal strength. The time required to acquire satellite signals varies based on several factors, including how far you are from the location where you last used your navigation device, whether you have a clear view of the sky, and how long it has been since you last used your navigation device. The first time you turn on your navigation device, it may take several minutes to acquire satellite signals.

- 1 Turn on the device.
- 2 Wait while the device locates satellites.
- 3 If necessary, go outdoors to an open area, away from tall buildings and trees.

When turns green, the device has acquired satellite signals and is ready for navigation.

Status Bar Icons

The status bar is located at the top of the main menu. The status bar icons display information about features on the device. You can select some icons to change settings or view additional information.

	GPS signal status. Hold to view GPS accuracy and acquired satellite information (<i>Viewing GPS Signal Status</i> , page 19).
	Bluetooth technology status. Select to view the Bluetooth settings (<i>Bluetooth Settings</i> , page 16).
	Connected to hands-free calling. Select to place a phone call (<i>Hands-Free Calling</i> , page 12).
	Active vehicle profile. Select to view the vehicle profile settings.
	Current time. Select to set the time (<i>Setting the Time</i> , page 16).
	Battery charge level.
	Fuel status. Select to view fuel tracking information.

Using the On-Screen Buttons

On-screen buttons allow you to navigate the pages, menus, and menu options on your device.

- Select to return to the previous menu screen.
- Hold to quickly return to the main menu.
- Select or to scroll through lists or menus.
- Hold or to scroll faster.
- Select to see a context-based menu of options for the current screen.

Adjusting the Volume

Before you can adjust the volume, you must connect your device to a powered mount or a headset using Bluetooth wireless technology.

- 1 Select **Volume**.
- 2 Select an option:
 - Use the slider bar to adjust the volume.
 - Select to mute the device.
 - Select for additional options.

Adjusting the Screen Brightness

- 1 Select **Settings > Display > Brightness**.
- 2 Use the slider bar to adjust the brightness.

Transportation Modes

Routing and navigation are calculated differently based on your transportation mode. The current transportation mode is indicated by an icon in the status bar.

	Automobile mode
	Motorcycle mode
	Off-road mode

Choosing a Transportation Mode

Select .

Using the On-Screen Keyboard

See "Language and Keyboard Settings" to change the keyboard layout ([Language and Keyboard Settings, page 16](#)).

- Select to delete a search entry.
- Select to delete a character.
- Select to change the keyboard language mode.
- Select to enter special characters, such as punctuation marks.
- Select to change character capitalization.

Using the Large Button Keyboard

You can enable additional keyboard languages or layouts in the language and keyboard settings ([Language and Keyboard Settings, page 16](#)).

- Select or to view more characters.
- Select to switch to other keyboard languages and layouts.

Rider Awareness Features and Alerts

NOTICE

The rider alerts and speed limit features are for information only and do not replace your responsibility to abide by all posted speed limit signs and to use safe driving judgment at all times. Garmin is not responsible for any traffic fines or citations you receive for failing to follow all applicable traffic laws and signs.

Your device provides features that can help encourage safer riding and increase efficiency, even when you are riding in a

familiar area. The device plays an audible tone or message and displays information for each alert. You can enable or disable the audible tone or message for each type of alert. Not all alerts are available in all areas.

School zone or nearby school: The device plays a tone and displays the distance to and speed limit (if available) for an upcoming school or school zone.

Speed limit reduction: The device plays a tone and displays the upcoming reduced speed limit so you can be prepared to reduce your speed.

Speed limit exceeded: The device plays a tone and displays a red border on the speed limit icon when you exceed the posted speed limit for the current road.

Railroad crossing: The device plays a tone and displays the distance to an upcoming railroad crossing.

Animal crossing: The device plays a tone and displays the distance to an upcoming animal crossing area.

Curve: The device plays a tone and displays the distance to a curve in the road.

Slower traffic: The device plays a tone and displays the distance to slower traffic when you approach slower traffic at a higher speed. Your device must be receiving traffic information to use this feature.

Fatigue warning: The device plays a tone and suggests upcoming rest stops after you have been driving for more than two hours without stopping.

Enabling or Disabling Rider Alerts

You can turn off individual audible rider alerts. Visual alerts appears even when the audible alert is disabled.

- 1 Select **Settings > Map & Vehicle > Audible Rider Alerts**.
- 2 Select or clear the check box next to each alert.

Red Light and Speed Cameras

NOTICE

Garmin is not responsible for the accuracy of or the consequences of using a red light or speed camera database.

NOTE: This feature is not available for all regions or product models.

Information about red light and speed camera locations is available in some areas for some product models. Go to garmin.com/speedcameras to check availability and compatibility, or to purchase a subscription or one-time update. You can purchase a new region or extend an existing subscription at any time.

You can go to mygarmin.com to update the camera database on your device. You should update your device frequently to receive the most up-to-date camera information.

For some devices and regions, basic red light or speed camera data may be included with your device. Included data does not include updates or a subscription.

Viewing Helmet Law Notifications

Helmet law and eye protection notifications may appear on your zūmo device the first time your device acquires satellites and when your device approaches a location with motorcycle safety rules.

NOTICE

Garmin recommends that all riders wear helmets for safety. Helmet law notifications are for reference only, are subject to change, and are not intended to be considered legal advice. Helmet law notifications are available in the U.S. and Canada only.

Select the notification to view more details.

Searching for Helmet Laws

You can search for helmet laws by state or province.

- 1 Select **Apps** > **Helmet Guide**.
- 2 Select a state or province.

Navigating to Your Destination

Routes

A route is a path from your current location to one or more destinations.

- The device calculates a recommended route to your destination based on the preferences you set, including the route calculation mode (*Changing the Route Calculation Mode, page 5*) and avoidances (*Avoiding Delays, Tolls, and Areas, page 7*).
- The device can automatically avoid roads that are not appropriate for the active vehicle profile.
- You can start navigating to your destination quickly using the recommended route, or you can select an alternate route (*Starting a Route, page 5*).
- If there are specific roads you need to use or avoid, you can customize the route (*Shaping Your Route, page 6*).
- You can add multiple destinations to a route (*Adding a Location to Your Route, page 6*).

Starting a Route

- 1 Select **Where To?**, and search for a location (*Finding and Saving Locations, page 8*).
- 2 Select a location.
- 3 Select an option:
 - To start navigating using the recommended route, select **Go!**.
 - To choose an alternate route, select **Y**, and select a route. Alternate routes appear to the right of the map.
 - To edit the course of the route, select **Y** > **Edit Route**, and add shaping points to the route (*Shaping Your Route, page 6*).

The device calculates a route to the location and guides you using voice prompts and information on the map (*Your Route on the Map, page 5*). A preview of the major roads in your route appears at the edge of the map for several seconds.

If you need to stop at additional destinations, you can add the locations to your route (*Adding a Location to Your Route, page 6*).



Changing the Route Calculation Mode

- 1 Select **Settings** > **Navigation** > **Calculation Mode**.
- 2 Select an option:
 - Select **Faster Time** to calculate routes that are faster to drive but can be longer in distance.
 - Select **Adventurous Route** to calculate routes that prefer curvy roads.
 - Select **Off Road** to calculate point-to-point routes (without roads).
 - Select **Shorter Distance** to calculate routes that are shorter in distance but can take more time to drive.

Taking a Route Using Adventurous Routing

Your device can calculate routes that prefer curvy roads, hills, and fewer highways. This feature can provide a more enjoyable ride, but it may increase the time or distance to your destination.

NOTE: This feature is not available on all device models or for all map regions.

- 1 Select **Settings** > **Navigation** > **Calculation Mode** > **Adventurous Route** > **Save**.
- 2 Select **Adventurous Route Settings**.
- 3 Use the  slider to include more or fewer curves.
- 4 Use the  slider to include more or fewer hills.
- 5 Use the  slider to include more or fewer highways.
- 6 Start a route (*Starting a Route, page 5*).

Creating a Round-Trip Route

The device can create a round-trip route using a specified starting location and a distance, duration, or destination.

- 1 From the home screen, select **Apps** > **Round Trip**.
- 2 Select **Start Location**.
- 3 Select a location, and select **Select**.
- 4 Select **Trip Attributes**.
- 5 Select an option:
 - Select **Choose a Distance** to plan your route by distance.
 - Select **Choose a Duration** to plan your route based on time.
 - Select **Choose a Destination** to plan your route based on a specified location.
- 6 Enter a distance, duration, or destination.
- 7 Select an option:
 - If you entered a distance or duration, select **Done** > **Calculate**.
 - If you selected a destination, select **Select**.
- 8 Select a route, and select **Go!**.

Starting a Route by Using the Map

You can start route by selecting a location from the map.

- 1 Select **View Map**.
- 2 Drag and zoom the map to display the area to search.
- 3 If necessary, select **Q** to filter the displayed points of interest by category. Location markers ( or a blue dot) appear on the map.
- 4 Select an option:
 - Select a location marker.
 - Select a point, such as a street, intersection, or address location.
- 5 Select **Go!**.

Going Home

The first time you start a route home, the device prompts you to enter your home location.

- 1 Select **Where To?** > **Go Home**.
- 2 If necessary, enter your home location.

Editing Your Home Location

- 1 Select **Where To?** >  > **Set Home Location**.
- 2 Enter your home location.

Your Route on the Map

As you travel, the device guides you to your destination using voice prompts and information on the map. Instructions for your next turn or exit, or other actions appear across the top of the map.

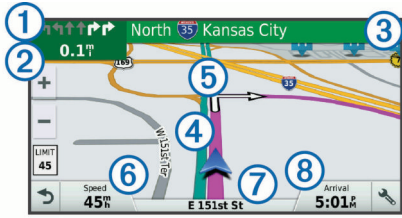

①	Next action in the route. Indicates the next turn, exit, or other action and the lane in which you should travel, if available.
②	Distance to the next action.
③	Name of the street or exit associated with the next action.
④	Route highlighted on the map.
⑤	Next action in the route. Arrows on the map indicate the location of upcoming actions.
⑥	Vehicle speed.
⑦	Name of the road on which you are traveling.
⑧	Estimated arrival time. TIP: You can touch this field to change the information it shows (Changing the Map Data Field, page 12).

Active Lane Guidance

As you approach a turn while navigating a route, a detailed simulation of the road appears beside the map, if available. A colored line ① indicates the proper lane for the turn.

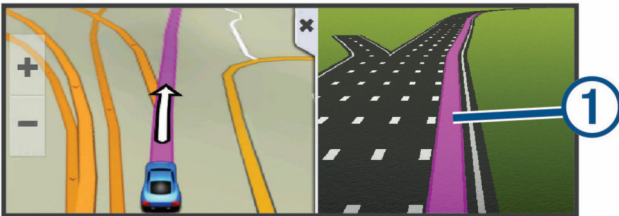

Viewing Turns and Directions

While navigating a route, you can view upcoming turns, lane changes, or other directions for your route.

- From the map, select an option:
 - To view upcoming turns and directions as you navigate, select **Turns**.
The map tool displays the next four turns or directions beside the map. The list updates automatically as you navigate the route.
 - To view the complete list of turns and directions for the entire route, select the text bar at the top of the map.
- Select a turn or direction (optional).
Detailed information appears. An image of the junction may appear for junctions on major roadways, if available.

Viewing the Entire Route on the Map

- While navigating a route, select anywhere on the map.
- Select **Where To?**.

Adding a Location to Your Route

Before you can add a location to your route, you must be navigating a route ([Starting a Route, page 5](#)).

You can add locations to the middle or end of your route. For example, you can add a fuel station as the next destination in your route.

TIP: To create complex routes with multiple destinations or scheduled stops, you can use the trip planner to plan, schedule, and save a trip ([Planning a Trip, page 7](#)).

- From the map, select **Where To?**.

- Search for a location ([Finding and Saving Locations, page 8](#)).
- Select a location.
- Select **Go!**.
- Select an option:
 - To add the location as the next destination in your route, select **Add As Next Stop**.
 - To add the location to the end of your route, select **Add As Last Stop**.
 - To add the location and edit the order of destinations in your route, select **Add to Active Route**.

The device re-calculates the route to include the added location and guides you to the destinations in order.

Shaping Your Route

Before you can shape your route, you must start a route ([Starting a Route, page 5](#)).

You can manually shape your route to change its course. This allows you to direct the route to use a certain road or go through a certain area without adding a destination to the route.

- Touch anywhere on the map.
- Select **Shape**.
The device enters route shaping mode.
- Select a location on the map.
TIP: You can select **+** to zoom in on the map and select a more precise location.
The device recalculates the route to travel through the selected location.
- If necessary, select an option:
 - To add more shaping points to the route, select additional locations on the map.
 - To remove a shaping point, select **Remove**.
- When you are finished shaping the route, select **Go!**.

Taking a Detour

You can take a detour for a specified distance along your route or detour around specific roads. This is useful if you encounter construction zones, closed roads, or poor road conditions.

- From the map, select **Change Route**.
TIP: If the Change Route tool is not in the map tools menu, you can add it ([Enabling Map Tools, page 11](#)).
- Select an option:
 - To detour your route for a specific distance, select **Detour by Distance**.
 - To detour around a specific road on the route, select **Detour by Road**.
 - To find a new route, select **Detour**.

Stopping the Route

From the map, select **Stop**.

Trip Planner

You can use the trip planner to create and save a trip, which you can navigate later. This can be useful for planning a delivery route, a vacation, or a road trip. You can edit a saved trip to further customize it, including reordering locations, optimizing the order of stops, adding scheduling information, and adding shaping points.

You can also use the trip planner to edit and save your active route.

Planning a Trip

A trip can include many destinations, and it must include at least a starting location and one destination. The starting location is the location from which you plan to start your trip. If you start navigating the trip from a different location, the device gives you the option to route to your starting location first. For a round trip, the starting location and final destination can be the same.

- 1 Select **Apps > Trip Planner > ≡ > Create Trip**.
- 2 Select **Select Start Location**.
- 3 Choose a location for your starting point, and select **Select**.
- 4 Select **Select Destination**.
- 5 Choose a location for a destination, and select **Select**.
- 6 Select **Add Location** to add more locations (optional).
- 7 After you have added all the necessary locations, select **Next > Save**.
- 8 Enter a name, and select **Done**.

Navigating to a Saved Trip

- 1 Select **Apps > Trip Planner**.
- 2 Select a saved trip.
- 3 Select **Go!**.
- 4 Select the first location to navigate to, and select **Start**.

The device calculates a route from your current location to the selected location and then guides you to the remaining trip destinations in order.

Optimizing the Order of Destinations in a Trip

The device can automatically optimize the order of destinations in your trip to create a shorter, more efficient route. The starting location and final destination are not changed when you optimize the order.

While editing a trip, select **≡ > Optimize Order**.

Editing and Reordering Locations in a Trip

- 1 Select **Apps > Trip Planner**.
- 2 Select a saved trip.
- 3 Select a location.
- 4 Select an option:
 - To move the location up or down, select **↕**, and drag the location to a new position in the trip.
 - To add a new location after the selected location, select **+**.
 - To remove the location, select **🗑**.

Changing Routing Options for a Trip

You can customize how the device calculates the route when you start your trip.

- 1 Select **Apps > Trip Planner**.
- 2 Select a saved trip.
- 3 Select the vehicle profile icon, and select the vehicle you plan to use while navigating the trip (optional).
- 4 Select **≡ > Trip Settings**.
- 5 Select an option:
 - To add shaping points to your trip, select **Shape Route**, and follow the on-screen instructions (*Shaping Your Route*, page 6).
 - To change the calculation mode for the trip, select **Route Preference** (*Changing the Route Calculation Mode*, page 5).

When you start navigating the trip, the device automatically switches to the selected vehicle profile.

Scheduling a Trip

You can add scheduling information to each location in your trip, including the desired arrival time and layover duration at each location. This can help you plan your departure to reach locations in your trip on time.

- 1 Select **Apps > Trip Planner**.
- 2 Select a trip.
- 3 Select **≡ > Trip Settings > Edit Schedule**.
- 4 Select a location, and follow the on-screen instructions to enter the schedule information.

TIP: If you need to schedule multiple locations in the trip, you should start from the beginning of the trip and work toward the end.
- 5 Repeat step 4 to enter schedule information for additional locations.
- 6 When finished, select **Save**.

When you navigate the trip, you should depart by the time shown under the starting point to reach your stops and destinations by the scheduled time. The schedule is an estimate only. Traffic conditions, construction, and other delays may affect your actual arrival times.

Sharing Trips

You can share trips with compatible Garmin devices using Bluetooth wireless technology.

- 1 Place your device within 33 ft. (10 m) of a compatible Garmin device.
- 2 Select **Apps > Trip Planner > ≡ > Share > Bluetooth**.
- 3 Select a trip and select **Done**.
- 4 Select a device from the list and select **OK**.

Using Suggested Routes

Before you can use this feature, you must save at least one location and enable the travel history feature (*Device and Privacy Settings*, page 16).

Using the myTrends™ feature, your device predicts your destination based on your travel history, the day of the week, and the time of day. After you have driven to a saved location several times, the location may appear in the navigation bar on the map, along with the estimated time of travel, and traffic information.

Select the navigation bar to view a suggested route to the location.

Avoiding Delays, Tolls, and Areas

Avoiding Toll Roads

Your device can avoid routing you through areas that require tolls, such as toll roads, toll bridges, or congestion areas. The device may still include a toll area in your route if no other reasonable routes are available.

- 1 Select **Settings > Navigation**.
- 2 Select an option:

NOTE: The menu changes based on your area and the map data on your device.

 - Select **Toll Roads**.
 - Select **Tolls and Fees > Toll Roads**.
- 3 Select an option:
 - To be asked each time before routing through a toll area, select **Always Ask**.
 - To always avoid tolls, select **Avoid**.
 - To always allow tolls, select **Allow**.
- 4 Select **Save**.

Avoiding Toll Stickers

NOTE: This feature is not available in all areas.

The map data on your device may contain detailed toll sticker information for some countries. You can avoid or allow toll stickers for each country.

- 1 Select **Settings > Navigation > Tolls and Fees > Toll Stickers**.
- 2 Select a country.
- 3 Select an option:
 - To be asked each time before routing through a toll area, select **Always Ask**.
 - To always avoid tolls, select **Avoid**.
 - To always allow tolls, select **Allow**.
- 4 Select **Save**.

Avoiding Road Features

- 1 Select **Settings > Navigation > Avoidances**.
- 2 Select the road features to avoid on your routes, and select **Save**.

Custom Avoidances

Custom avoidances allow you select specific areas or sections of road to avoid. When the device calculates a route, it avoids these areas and roads unless no other reasonable route is available.

Avoiding a Road

- 1 Select **Settings > Navigation > Custom Avoidances**.
- 2 Select **Add Avoid Road**.
- 3 Select the starting point of the section of road to avoid, and select **Next**.
- 4 Select the ending point of the road section, and select **Next**.
- 5 Select **Done**.

Avoiding an Area

- 1 Select **Settings > Navigation > Custom Avoidances**.
- 2 If necessary, select **Add Avoidance**.
- 3 Select **Add Avoid Area**.
- 4 Select the upper-left corner of the area to avoid, and select **Next**.
- 5 Select the lower-right corner of the area to avoid, and select **Next**.

The selected area is shaded on the map.



- 6 Select **Done**.

Disabling a Custom Avoidance

You can disable a custom avoidance without deleting it.

- 1 Select **Settings > Navigation > Custom Avoidances**.
- 2 Select an avoidance.
- 3 Select  > **Disable**.

Deleting Custom Avoidances

- 1 Select **Settings > Navigation > Custom Avoidances**.
- 2 Select an option:
 - To delete all custom avoidances, select .
 - To delete one custom avoidance, select the avoidance, and select  > **Delete**.

Navigating Off Road

If you are not following roadways as you navigate, you can use Off Road mode.

- 1 Select **Settings > Navigation**.
- 2 Select **Calculation Mode > Off Road > Save**.

The next route will be calculated as a straight line to the location.

Fuel Tracking

You can set your device to estimate your fuel usage, warn you when you approach the maximum estimated fuel distance, and suggest fuel stops based on your estimated fuel range. When fuel tracking is enabled,  indicates the current fuel status.

White: Fuel tracking is disabled, or the device is not connected to the motorcycle mount.

Green: The estimated fuel range is above the fuel tank warning level.

Orange: The estimated fuel range is below the fuel tank warning level.

Red: The estimated distance remaining on the tank is 0.

Enabling Fuel Tracking

Before you can enable fuel tracking, the device must be in motorcycle mode or off road mode and placed in the motorcycle mount.

When you enable fuel tracking, a fuel gauge appears on the trip computer ([Viewing the Trip Information Page, page 12](#)).

- 1 Fill your fuel tank.
- 2 Select **Apps > Fuel Settings > Fuel Tracking**.
- 3 Select **Distance Per Tank**.
- 4 Enter the distance the vehicle travels on a tank of gas and select **Done**.

Setting a Low Fuel Warning

You can set the device to warn you when the tank is low on fuel.

NOTE: The device must be connected to the motorcycle mount to give low fuel warnings.

- 1 Enable fuel tracking ([Enabling Fuel Tracking, page 8](#)).
- 2 Select **Fuel Tank Warning**.
- 3 Enter a distance, and select **Done**.

When you have only enough fuel left to travel the distance you entered, a low fuel warning appears on the map page.

Resetting the Fuel Tank Mileage

When you refill your fuel tank, you should reset the fuel tank mileage on your device to more accurately track your remaining fuel.

Select **Apps > Fuel Settings > Reset Fuel Tank**.

Enabling Dynamic Fuel Stops

Before you can enable dynamic fuel stops, the device must be in motorcycle mode, placed in the motorcycle mount, and fuel tracking must be enabled.

You can set the device to suggest fuel stops based on your estimated fuel range.

Select **Apps > Fuel Settings > Dynamic Fuel Stops**.

Finding and Saving Locations

The maps loaded in your device contain locations, such as restaurants, hotels, auto services, and detailed street information. The Where To? menu helps you find your destination by providing several methods to browse, search, and save this information.

- Enter search terms to quickly search all location information ([Finding a Location Using the Search Bar, page 9](#)).
- Browse or search pre-loaded points of interest by category ([Points of Interest, page 9](#)).
- Search and check into Foursquare® points of interest ([Searching Foursquare Points of Interest, page 9](#)).

- Use search tools to find specific locations, such as addresses, intersections, or geographic coordinates ([Search Tools](#), page 9).
- Search near a different city or area ([Changing the Search Area](#), page 9).
- Save your favorite locations to find them quickly in the future ([Saving Locations](#), page 10).
- Return to recently found locations ([Viewing Recently Found Locations](#), page 10).



Finding a Location Using the Search Bar

You can use the search bar to search for locations by entering a category, brand name, address, or city name.

- 1 Select **Where To?**.
- 2 Select **Enter Search** in the search bar.
- 3 Enter all or part of the search term.
Suggested search terms appear below the search bar.
- 4 Select an option:
 - To search for a type of business, enter a category name (for example, "movie theaters").
 - To search for a business name, enter all or part of the name.
 - To search for an address near you, enter the house number and street name.
 - To search for an address in another city, enter the house number, street name, city, and state.
 - To search for a city, enter the city and state.
 - To search for coordinates, enter latitude and longitude coordinates.
- 5 Select an option:
 - To search using a suggested search term, select the term.
 - To search using the text you entered, select **Q**.
- 6 If necessary, select a location.

Viewing Search Results on the Map

You can view the results of a location search on the map instead of in a list.

- 1 From the location search results, select .
The nearest location in your search results appears on the map.  indicates the locations of other search results.
- 2 Select one or more options:
 - To view more search results, touch and drag the map.
 - To select another location, select .
 - To view details and routes for the selected location, select the location description at the bottom of the map.
 - To start navigation to the selected location, select **Go!**.

Changing the Search Area

By default, the device searches near your current location. You can also search other areas, such as near your destination, near another city, or along your active route.

- 1 From the main menu, select **Where To?**.
- 2 Select .
- 3 Select an option.

Points of Interest

A point of interest is a place that you may find useful or interesting. Points of interest are organized by category and can include popular travel destinations such as gas stations, restaurants, hotels, and entertainment venues.

Finding a Location by Category

- 1 Select **Where To?**.
- 2 Select a category, or select **Categories**.
- 3 If necessary, select a subcategory.
- 4 Select a location.

Searching Within a Category

After you have performed a search for a point of interest, certain categories may display a Quick Search list that shows the last four destinations you selected.

- 1 Select **Where To? > Categories**.
- 2 Select a category.
- 3 Select an option:
 - Select a destination from the quick search list on the right side of the screen.
The quick search list provides a list of recently found locations in the selected category.
 - Select a subcategory, if necessary, and select a destination.

Navigating to Points of Interest Within a Venue

You can create a route to a point of interest (POI) within a larger venue, such as a store in a shopping mall or a specific terminal in an airport.

- 1 Select **Where To? > Enter Search**.
- 2 Select an option:
 - To search for the venue, enter the name or address of the venue, select **Q**, and go to step 3.
 - To search for the POI, enter the name of the POI, select **Q**, and go to step 5.
- 3 Select the venue.
A list of categories appears below the venue, such as restaurants, car rentals, or terminals.
- 4 Select a category.
- 5 Select the POI, and select **Go!**.

The device creates a route to the parking area or venue entrance closest to the POI. When you arrive at the destination, a checkered flag indicates the recommended parking area. A labeled point indicates the location of the POI within the venue.

Exploring a Venue

You can view a list of all points of interest located within each venue.

- 1 Select a venue.
- 2 Select  **> Explore this Venue**.

Foursquare

Foursquare is a location-based social network. Your device includes pre-loaded Foursquare points of interest, which are indicated by the Foursquare logo in your location search results.

Searching Foursquare Points of Interest

You can search for Foursquare points of interest loaded on your device.

Select **Where To? > Categories > Foursquare**.

Search Tools

Search tools allow you to search for specific types of locations by responding to on-screen prompts.

Finding an Address

NOTE: The order of the steps may change depending on the map data loaded on your device.

- 1 Select **Where To?**.

- 2 If necessary, select **Searching Near** to change the search area (*Changing the Search Area, page 9*).
- 3 Select **Address**.
- 4 Follow the on-screen instructions to enter address information.
- 5 Select the address.

Finding an Intersection

You can search for an intersection or junction between two streets, highways, or other roads.

- 1 Select **Where To? > Categories > Intersections**.
- 2 Follow the on-screen instructions to enter street information.
- 3 Select the intersection.

Finding a City

- 1 Select **Where To? > Categories > Cities**.
- 2 Select an option:
 - Select a city from the list of nearby cities.
 - To search near another location, select **Searching Near** (*Changing the Search Area, page 9*).
 - To search for a city by name, select **Enter Search**, enter a city name, and select **Q**.

Finding a Location Using Coordinates

You can find a location using latitude and longitude coordinates. This can be helpful when geocaching.

- 1 Select **Where To? > Categories > Coordinates**.
- 2 If necessary, select , and change the coordinate format or datum.
- 3 Enter the latitude and longitude coordinates.
- 4 Select **View on Map**.

Viewing Recently Found Locations

Your device stores a history of the last 50 locations you have found.

Select **Where To? > Recent**.

Clearing the List of Recently Found Locations

Select **Where To? > Recent > ≡ > Clear > Yes**.

Finding Your Last Parking Spot

When you disconnect the device from vehicle power while the device is on, your current location is saved as a parking spot.

Select **Apps > Last Spot**.

Viewing Current Location Information

You can use the *Where Am I?* page to view information about your current location. This feature is helpful if you need to tell emergency personnel your location.

From the map, select the vehicle.

Finding Emergency Services and Fuel

You can use the *Where Am I?* page to find the nearest hospitals, police stations, and fuel stations.

- 1 From the map, select the vehicle.
- 2 Select **Hospitals, Police Stations, Fuel, or Roadside Assist..**

NOTE: Some service categories are not available in all areas.

A list of locations for the selected service appears, with the nearest locations at the top.

- 3 Select a location.
- 4 Select an option:
 - To navigate to the location, select **Go!**.

- To view the phone number and other location details, select **i**.

Getting Directions to Your Current Location

If you need to tell another person how to get to your current location, your device can give you a list of directions.

- 1 From the map, select the vehicle.
- 2 Select **≡ > Directions to Me**.
- 3 Select a starting location.
- 4 Select **Select**.

Adding a Shortcut

You can add shortcuts to the *Where To?* menu. A shortcut can point to a location, a category, or a search tool.

The *Where To?* menu can contain up to 36 shortcut icons.

- 1 Select **Where To? > Add Shortcut**.
- 2 Select an item.

Removing a Shortcut

- 1 Select **Where To? > ≡ > Remove Shortcut(s)**.
- 2 Select a shortcut to remove.
- 3 Select the shortcut again to confirm.
- 4 Select **Save**.

Saving Locations

Saving a Location

- 1 Search for a location (*Finding a Location by Category, page 9*).
- 2 From the search results, select a location.
- 3 Select **i**.
- 4 Select **Save**.
- 5 If necessary, enter a name, and select **Done**.

Saving Your Current Location

- 1 From the map, select the vehicle icon.
- 2 Select **Save**.
- 3 Enter a name, and select **Done**.
- 4 Select **OK**.

Editing a Saved Location



- 1 Select **Where To? > Saved**.
- 2 If necessary, select a category.
- 3 Select a location.
- 4 Select **i**.
- 5 Select **≡ > Edit**.
- 6 Select an option:
 - Select **Name**.
 - Select **Phone Number**.
 - Select **Categories** to assign categories to the saved location.
 - Select **Change Map Symbol** to change the symbol used to mark the saved location on a map.
- 7 Edit the information.
- 8 Select **Done**.

Assigning Categories to a Saved Location

You can add custom categories to organize your saved locations.

NOTE: Categories appear in the saved locations menu after you have saved at least 12 locations.

- 1 Select **Where To? > Saved**.

- 2 Select a location.
- 3 Select .
- 4 Select  > **Edit** > **Categories**.
- 5 Enter one or more category names, separated by commas.
- 6 If necessary, select a suggested category.
- 7 Select **Done**.



Deleting a Saved Location

NOTE: Deleted locations cannot be recovered.

- 1 Select **Where To?** > **Saved**.
- 2 Select  > **Delete Saved Places**.
- 3 Select the box next to the saved locations to delete, and select **Delete**.





Sharing a Saved Location

After you save a location, you can share it with other compatible Garmin devices using Bluetooth wireless technology or a memory card.

- 1 Select **Where To?** > **Saved**.
- 2 If necessary, select a category.
- 3 Select a location.
- 4 Select .
- 5 Select  > **Share**.
- 6 Follow the on-screen instructions to share location information.

Using the Map

You can use the map to navigate a route (*Your Route on the Map*, page 5) or to view a map of your surroundings when no route is active.

- 1 Select **View Map**.
- 2 Touch anywhere on the map.
- 3 Select an option:
 - Drag the map to pan left, right, up, or down.
 - To zoom in or out, select  or .
 - To switch between North Up and 3-D views, select .
 - To filter the displayed points of interest by category, select .
 - To start a route, select a location on the map, and select **Go!** (*Starting a Route by Using the Map*, page 5).

Map Tools

Map tools provide quick access to information and device functions while you view the map. When you activate a map tool, it appears in a panel at the edge of the map.

Stop: Stops navigation of the active route.

Change Route: Allows you to take a detour or skip locations in your route.

Up Ahead: Displays upcoming locations along the route or the road on which you are traveling (*Up Ahead*, page 11).

Turns: Displays a list of upcoming turns in your route (*Viewing Turns and Directions*, page 6).

Trip Data: Displays customizable trip data, such as speed or mileage (*Viewing Trip Data from the Map*, page 11).

Volume: Adjusts the master audio volume.

Brightness: Adjusts the screen brightness.



Phone: Displays a list of recent phone calls from your connected phone, and displays in-call options while a phone call is active (*Using In-Call Options*, page 13).

Viewing a Map Tool

- 1 From the map, select .
- 2 Select a map tool.
The map tool appears in a panel at the edge of the map.
- 3 When you are done using the map tool, select **X**.

Enabling Map Tools

By default, only the most commonly used map tools are enabled in the map tools menu. You can add up to 12 tools to the menu.



- 1 From the map, select  > .
- 2 Select the check box next to each tool to add.
- 3 Select **Save**.

Up Ahead

The Up Ahead tool provides information about upcoming locations along your route or the road on which you are traveling. You can view upcoming points of interest, such as restaurants, fuel stations, or rest areas. When traveling on a highway, you can also view information and available services for upcoming exits and cities, similar to the information on highway road signs.

You can customize three categories to show in the Up Ahead tool.



Viewing Upcoming Locations

- 1 From the map, select  > **Up Ahead**.
- 2 Select an option:
 - To view the next upcoming location in each category, select , if necessary.
 - To view information and available services for upcoming highway exits or cities, select .

NOTE: This option is available only while you are traveling on a highway or when your route includes a highway.
- 3 Select an item to view a list of locations for that category, exit, or city.

Customizing the Up Ahead Categories

You can change the location categories that appear in the Up Ahead tool.

- 1 From the map, select  > **Up Ahead**.
- 2 Select a category.
- 3 Select .
- 4 Select an option:
 - To move a category up or down in the list, select and drag the arrow next to the category name.
 - To change a category, select the category.
 - To create a custom category, select a category, select **Custom Search**, and enter the name of a business or category.
- 5 Select **Done**.

Trip Information

Viewing Trip Data from the Map

Before you can view trip data on the map, you must add the tool to the map tools menu (*Enabling Map Tools*, page 11).

From the map, select  > **Trip Data**.

Customizing the Trip Data Fields

Before you can customize the data that appears in the trip data map tool, you must add the trip data tool to the map tools menu (*Enabling Map Tools*, page 11).

- 1 From the map, select  > **Trip Data**.
- 2 Select a trip data field.
- 3 Select an option.

The new trip data field appears in the trip data map tool.

Viewing the Trip Information Page

The trip information page displays your speed and provides statistics about your trip.

NOTE: If you make frequent stops, leave the device turned on, so it can accurately measure elapsed time during the trip.

From the map, select **Speed**.

Viewing the Trip Log

Your device keeps a trip log, which is a record of the path you have traveled.

1 Select **Settings > Map & Vehicle > Map Layers**.

2 Select the **Trip Log** check box.

Resetting Trip Information

1 From the map, select **Speed**.

2 Select  > **Reset Field(s)**.

3 Select an option:

- When not navigating a route, select **Select All** to reset every data field except the speedometer, on the first page.
- Select **Reset Trip Data** to reset the information on the trip computer.
- Select **Reset Max. Speed** to reset the maximum speed.
- Select **Reset Trip B** to reset the odometer.

Customizing the Map

Customizing the Map Layers

You can customize which data appear on the map, such as icons for points of interest and road conditions.

1 Select **Settings > Map & Vehicle > Map Layers**.

2 Select the layers to include on the map, and select **Save**.

Changing the Map Data Field

1 From the map, select a data field.

NOTE: You cannot customize Speed.

2 Select a type of data to display.

Changing the Map Perspective

1 Select **Settings > Map & Vehicle > Driving Map View**.

2 Select an option:

- Select **Track Up** to display the map in two dimensions (2-D), with your direction of travel at the top.
- Select **North Up** to display the map in 2-D with north at the top.
- Select **3-D** to display the map in three dimensions.

3 Select **Save**.

Bluetooth Connected Features

The device has several Bluetooth connected features for your compatible smartphone.

Hands-free calling: Allows you to place and receive phone calls using your device, and allows you to use the device as a hands-free speaker phone.

Media streaming: Streams audio from your smartphone to your headset and provides Bluetooth media controls on your zūmo device.

Bluetooth Feature Requirements

Some features require a phone, a headset, or a specific app on your smartphone.

Feature	Requires
Hands free calling	Paired phone and headset.
Media streaming	Paired smartphone and headset.

Pairing Your Phone and Headset

You must pair your zūmo device with your phone and Bluetooth headset to use several Bluetooth features. After the devices are paired, they connect automatically when they are turned on and within range.

1 On your phone, enable Bluetooth wireless technology, and set the phone to be discoverable.

See your phone owner's manual for more information.

2 Place the zūmo device and your phone within 3 m (10 ft.) of each other.

3 On the zūmo device, select **Settings > Bluetooth > **.

4 Follow the on-screen instructions to pair your phone with your device.

5 On the zūmo device, select .

TIP: If the initial Bluetooth settings screen does not appear, you can select **Settings > Bluetooth > Search for Devices** to pair your headset.



6 Follow the on-screen instructions to pair your headset with your device.

Bluetooth Feature Status Icons

Status icons appear in the Bluetooth settings next to each paired device.

Select **Settings > Bluetooth**.

- A gray icon indicates the feature is disabled or disconnected for that device.
- A colored icon indicates the feature is connected and active for that device.

	Hands-free calling
	Media streaming
	Headset is connected

Enabling or Disabling Bluetooth Features for Your Headset

By default, all compatible Bluetooth features are enabled when you pair your headset. You can enable or disable certain features.

1 Select **Settings > Bluetooth**.

2 Select the headset name.

3 Select an option:

- To disconnect the headset, clear the **Headset** check box.
- To disable audio from streaming media, clear the **Media Audio** check box.

Hands-Free Calling

NOTE: While most phones and headsets are supported and can be used, it cannot be guaranteed that a particular phone or headset can be used. All features may not be available for your phone.

Using Bluetooth wireless technology, your device can connect to your mobile phone and wireless headset or helmet to become a hands-free device. To determine whether your device with Bluetooth technology is compatible with your device, go to www.garmin.com/bluetooth.

Placing a Call

Dialing a Number

1 Select **Apps > Phone > Dial**.

- 2 Enter the number.
- 3 Select **Dial**.

Calling a Contact in Your Phone Book

Your phone book is loaded from your phone to the device each time your phone and the device connect. It may take a few minutes for the phone book to be available. Some phones do not support this feature.

- 1 Select **Apps > Phone > Phone Book**.
- 2 Select a contact.
- 3 Select **Call**.

Calling a Location

- 1 Select **Apps > Phone > Browse Categories**.
- 2 Select a point of interest.
- 3 Select **Call**.

Receiving a Call

When you receive a call, select **Answer** or **Ignore**.





Using the Call History

Your call history is loaded from your phone to the device each time your phone and the device connect. It may take a few minutes for the call history to be available. Some phones do not support this feature.

- 1 Select **Apps > Phone > Call History**.
- 2 Select a category.
A list of calls appears, with the most recent calls at the top.
- 3 Select a call.

Using In-Call Options

While on a call, you can select in-call options from the map.

- To transfer audio to your phone, select .
TIP: You can use this feature if you want to turn off your device and remain on the call, or if you need privacy.
- To use the dial pad, select .
TIP: You can use this feature to use automated systems, such as voice mail.
- To mute the microphone, select .
- To hang up, select .

Saving a Home Phone Number

TIP: After you save a home number, you can edit the home number by editing “Home” in your list of saved locations (*Editing a Saved Location, page 10*).

- 1 Select **Apps > Phone >  > Set Home Number**.
- 2 Enter your phone number.
- 3 Select **Done**.

Calling Home

Before you can call home, you must enter a phone number for your home location.

Select **Apps > Phone > Call Home**.

Disconnecting a Bluetooth Device

You can temporarily disconnect a Bluetooth device without deleting it from the paired devices list. The Bluetooth device can connect to your zūmo device automatically in the future.

- 1 Select **Settings > Bluetooth**.
- 2 Select the device to disconnect.
- 3 Clear the check box next to the name of your paired device.

Deleting a Paired Phone

You can delete a paired phone to prevent it from automatically connecting to your device in the future.

- 1 Select **Settings > Bluetooth**.
- 2 Select the phone, and select **Unpair device**.

Using the Apps

Media Player

The media player can play music or audio from these sources.

- Music files stored on your zūmo device.
- Music files stored on a phone or media player connected to the motorcycle mount USB port.
- Bluetooth audio from a paired phone.

Adding the Media Player Tool to the Map

The media player map tool enables you to control the media player from your map.

- 1 Select **Settings > Map & Vehicle > Map Tools > Media Player**.
- 2 Open the map.
- 3 Select  > **Media Player**.
The media player controls appear on the map.

Changing the Media Source

You can change the source from which media is played on your device.

- 1 Select **Apps > Media Player > **.
- 2 Select a media source.

Tracks

A track is a recording of your path. The track log contains information about the recorded path, including time, location, and elevation information.

Viewing Track Information

- 1 Select **Apps > Tracks > Active**.
- 2 Select a track.
The track is displayed on the map.
- 3 Select .
- 4 Select an option:
 - To save the track, select **Save Track**.
 - To save the track as a trip, select **Save as Trip**.
 - To view an elevation plot of the track, select **Elevation Profile**.

TracBack®

Following Your Recent Track

The TracBack feature records a track of your recent movement. You can retrace your recent track back to where you started.

- 1 Select **Apps > TracBack**.
Your recent track appears on the map.
- 2 Select **Go!**.

Saving Your Recent Track as a Trip

You can save your recent track as a trip, which you can navigate later using the trip planner (*Navigating to a Saved Trip, page 7*).

- 1 Select **TracBack**.
Your recent track appears on the map.
- 2 Select  > **Save as Trip**.
- 3 Enter a name, and select **Done**.

Tire Pressure

⚠ WARNING

Use of the Tire Pressure Monitor System is not a substitute for proper tire maintenance, and it is the driver's responsibility to maintain correct tire pressure, even if under-inflation has not reached the level to trigger the low tire pressure alert. Failure to maintain proper tire pressure can result in loss of control of the vehicle, which may lead to serious personal injury or death.

The Garmin Tire Pressure Monitor System is available as a separate accessory. The tire pressure feature is not compatible with all zūmo models. Go to www.garmin.com/zumo for accessory and compatibility information.

Setting Up the Tire Pressure Sensors

Before you can set up the tire pressure sensors, you must have the battery and the numerical stickers included with each sensor. You also must have a compatible zūmo device.

The sensors communicate wirelessly with your compatible zūmo device. You can monitor tire pressure and receive low-pressure alerts on your zūmo device.

- 1 Remove the cap ① from the sensor ② by rotating the cap counter-clockwise.

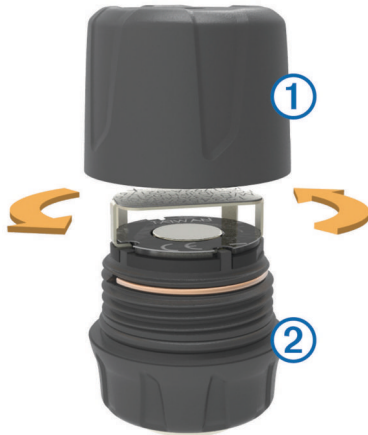

- 2 If you have already installed the battery in the sensor, remove the battery.
- 3 On your zūmo device, select **Apps > Tire Pressure**.
- 4 Select a vehicle profile that matches the tire configuration of your vehicle.
- 5 Bring the sensor close to the zūmo device.
- 6 On your zūmo device, select the number next to the tire to which the sensor will be paired.
- 7 Within 30 seconds, on the sensor, insert the battery ③ into the battery holder ④ with the positive side facing up.

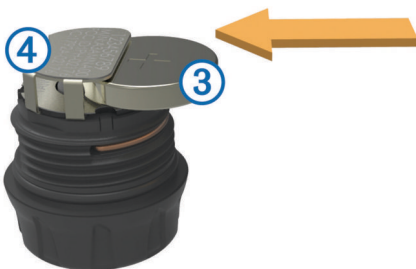

The zūmo device searches for the sensor and displays a confirmation message when the sensor pairs successfully.

TIP: If the sensor does not pair successfully, you should remove the sensor battery, and repeat steps 6 and 7.

- 8 Enter the recommended pressure for the tire.

- 9 Enter the minimum pressure for the tire.

The zūmo device triggers a low-pressure alert when the sensor reports a tire pressure reading lower than this value.

- 10 Replace and fully tighten the cap on the sensor.

- 11 On the sensor, affix the numerical sticker that corresponds to the tire number you selected in step 6.

- 12 Repeat this procedure for each remaining sensor.

Installing the Sensors on Your Tires

⚠ WARNING

The Tire Pressure Monitor System is for use with metal tire valve stems only. Installation of the Tire Pressure Sensors on non-metal tire valve stems may cause tire and/or tire valve stem damage which could result in serious personal injury or death.

NOTICE

To prevent possible damage to the sensors or vehicle, ensure each installed sensor does not interfere with the vehicle brakes, suspension components, or other installed equipment. If an installed sensor interferes with any installed equipment on the vehicle, do not operate the vehicle with the sensor installed.

To prevent possible tire vibration or uneven tire wear on some vehicles, it may be necessary to balance the vehicle tires after installing the sensor.

Before you install the sensors on your tires, you should set up the sensors with your zūmo device.

- 1 Remove the existing valve stem caps from your vehicle tires.
- 2 On your zūmo device, select **Apps > Tire Pressure** to view the vehicle profile diagram.
- 3 Install the sensors onto the tire valve stems by tightening them clockwise.

NOTE: You must install each sensor onto the correct tire based on the vehicle profile diagram and the numerical stickers affixed to the sensors during the setup process.

- 4 Rotate the wheels by hand to verify the sensors have adequate clearance and do not interfere with vehicle equipment.

Tire Pressure Alerts

The device alerts you using pop-up messages, icons on the map, and symbols in the tire pressure app.

When an alert exists for a sensor, the number next to the corresponding tire appears red in the tire pressure app. The symbols below the number appear red to indicate the active alerts for that sensor.

⚠	Low tire pressure
🔋	Low sensor battery
✖	Sensor not connected

Tire Pressure Sensor Sleep Mode

When you park your vehicle and turn off your zūmo device, the tire pressure sensor enters a power-saving sleep mode after several minutes. The sensor does not transmit information to the zūmo device while in sleep mode. This can cause your zūmo device to report the sensor is disconnected.

The next time your vehicle moves, the sensor exits sleep mode and automatically reconnects to the zūmo device. It may take up to 30 seconds to reconnect.

Using the Compass

NOTE: You must be moving for the compass to determine your direction.

You can navigate using a GPS compass.

Select **Apps > Compass**.

VIRB® Remote

The VIRB remote function allows you to control your VIRB action camera using your device. Go to www.garmin.com/VIRB to purchase a VIRB action camera.

Controlling a VIRB Action Camera

Before you can use the VIRB remote function, you must enable the remote setting on your VIRB camera. See the *VIRB Series Owner's Manual* for more information.

- 1 Turn on your VIRB camera.
- 2 On your zūmo device, select **Apps > VIRB Remote > Connect**.
- 3 Wait while the device connects to your VIRB camera.
- 4 Select an option:
 - Select **Start Recording** to record video.
 - Select **Stop Recording** to stop recording video.
 - Select **Snapshot** to take a photograph.

Logging Service History

You can log the date and odometer reading when service or maintenance is performed on your vehicle. The device provides several service categories, and you can add custom categories ([Adding Service Categories, page 15](#)).

- 1 Select **Apps > Service History**.
- 2 Select a service category.
- 3 Select **Add Record**.
- 4 Enter the odometer reading, and select **Next**.
- 5 Enter a comment (optional).
- 6 Select **Done**.

Adding Service Categories

- 1 Select **Apps > Service History**.
- 2 Select  > **Add Category**.
- 3 Enter a category name, and select **Done**.

Deleting Service Categories

When you delete a service category, all service records in the category are also deleted.

- 1 Select **Apps > Service History**.
- 2 Select  > **Delete Categories**.
- 3 Select the service categories to delete.
- 4 Select **Delete**.

Renaming Service Categories

- 1 Select **Apps > Service History**.
- 2 Select the category to be renamed.
- 3 Select  > **Rename Category**.
- 4 Enter a name, and select **Done**.

Deleting Service Records

- 1 Select **Apps > Service History**.
- 2 Select a service category.
- 3 Select  > **Delete Records**.
- 4 Select the service records to be deleted.
- 5 Select **Delete**.

Editing a Service Record

You can edit the comment, odometer reading, and date of a service record.

- 1 Select **Apps > Service History**.
- 2 Select a category.
- 3 Select a field.

- 4 Enter the new information, and select **Done**.

Viewing Help Files

Select **Apps > Help** to view the full owner's manual.

Searching Help Topics

Select **Apps > Help > Q**.

Viewing Previous Routes and Destinations

Before you can use this feature, you must enable the travel history feature ([Device and Privacy Settings, page 16](#)).

You can view your previous routes and places you have stopped on the map.

Select **Apps > Where I've Been**.

Customizing the Device

Map and Vehicle Settings

Select **Settings > Map & Vehicle**.

Vehicle: Sets the icon that represents your position on the map. Go to www.garmin.com for more icons.

Driving Map View: Sets the perspective on the map.

Map Detail: Sets the level of detail on the map. More detail may cause the map to draw slower.

Map Theme: Changes the color of the map data.

Map Tools: Sets the shortcuts that appear in the map tools menu.

Map Layers: Sets the data that appears on the map page ([Customizing the Map Layers, page 12](#)).

Audible Rider Alerts: Enables an audible alert for each type of rider alert ([Rider Awareness Features and Alerts, page 4](#)).

Auto Zoom: Automatically selects the zoom level for optimal use of your map. When disabled, you must zoom in or out manually.

myMaps: Sets which installed maps the device uses.

Enabling or Disabling Rider Alerts

You can turn off individual audible rider alerts. Visual alerts appears even when the audible alert is disabled.

- 1 Select **Settings > Map & Vehicle > Audible Rider Alerts**.
- 2 Select or clear the check box next to each alert.

Enabling Maps

You can enable map products installed on your device.

TIP: To purchase additional map products, go to <http://buy.garmin.com>.

- 1 Select **Settings > Map & Vehicle > myMaps**.
- 2 Select a map.

Navigation Settings

Select **Settings > Navigation**.

Route Preview: Shows a preview of the major roads in your route when you start navigation.

Calculation Mode: Sets the route calculation method.

Off-Route Recalculation: Sets recalculation preferences when navigating away from an active route.

Fatigue Warning: Alerts you when you have been driving for a long period without a break.

Avoidances: Sets road features to avoid on a route.

Custom Avoidances: Allows you to avoid specific roads or areas.

Toll Roads: Sets preferences for avoiding toll roads.

Tolls and Fees: Sets preferences for avoiding toll roads and toll stickers.

NOTE: This feature is not available in all areas.

Restricted Mode: Disables all functions that require significant operator attention and could become a distraction while driving.

GPS Simulator: Stops the device from receiving a GPS signal, and saves battery power.

Calculation Mode Settings

Select **Settings > Navigation > Calculation Mode**.

The route calculation is based on road speeds and vehicle acceleration data for a given route.

Faster Time: Calculates routes that are faster to drive but can be longer in distance.

Shorter Distance: Calculates routes that are shorter in distance but can take more time to drive.

Off Road: Calculates a direct line from your location to your destination.

Adventurous Route: Calculates routes that prefer curvy roads.

NOTE: This feature is not available in all areas.

Setting a Simulated Location

If you are indoors or not receiving satellite signals, you can use the GPS to set a simulated location.

1 Select **Settings > Navigation > GPS Simulator**.

2 From the main menu, select **View Map**.

3 Tap the map twice to select an area.

The address of the location appears at the bottom of the screen.

4 Select the location description.

5 Select **Set Location**.

Bluetooth Settings

Select **Settings > Bluetooth**.

Bluetooth: Enables Bluetooth wireless technology.

Search for Devices: Searches for nearby Bluetooth devices.

Friendly Name: Allows you to enter a friendly name that identifies your device on other devices with Bluetooth wireless technology.

Disabling Bluetooth

1 Select **Settings > Bluetooth**.

2 Select **Bluetooth**.

Display Settings

Select **Settings > Display**.

Color Mode: Allows you to select day or night color mode. If you select the Auto option, the device automatically switches to day or night colors based on the time of day.

Brightness: Allows you to adjust the display brightness.

Display Timeout: Allows you to set the amount of idle time before your device enters sleep mode while using battery power.

Screenshot: Allows you to take a picture of the device screen. Screenshots are saved in the Screenshot folder of the device storage.

Units and Time Settings

To open the Units and Time settings page, from the main menu, select **Settings > Units & Time**.

Current Time: Sets the device time.

Time Format: Allows you to select a 12-hour, 24-hour, or UTC display time.

Units: Sets the unit of measure used for distances.

Position Format: Sets the coordinate format and datum used for geographical coordinates.

Setting the Time

1 From the main menu, select the time.

2 Select an option:

- To set the time automatically using GPS information, select **Automatic**.
- To set the time manually, drag the numbers up or down.

Language and Keyboard Settings

To open the Language and Keyboard settings, from the main menu, select **Settings > Language & Keyboard**.

Voice Language: Sets the language for voice prompts.

Text Language: Sets all on-screen text to the selected language.

NOTE: Changing the text language does not change the language of user-entered data or map data, such as street names.

Keyboard Language: Enables keyboard languages.

Keyboard Layout: Sets the keyboard layout.

Proximity Alerts Settings

NOTE: You must have custom points of interest (POIs) loaded for proximity points alerts to display.

NOTE: This feature is not available in all areas.

Select **Settings > Proximity Alerts**.

Audio: Sets the style of alert that plays when you approach proximity points.

Alerts: Sets the type of proximity points for which alerts are played.

Device and Privacy Settings

To open the device settings, select **Settings > Device**.

About: Displays the software version number, the unit ID number, and information on several other software features.

EULAs: Displays the end-user license agreements.

NOTE: You need this information when you update the system software or purchase additional map data.

Position Reporting: Shares your position information with Garmin to improve content.

Travel History: Allows the device to record information for the myTrends, Where I've Been, and Trip Log features.

Clear Travel History: Clears your travel history for the myTrends, Where I've Been, and Trip Log features.

Restoring Settings

You can restore a category of settings or all settings to the factory default values.

1 Select **Settings**.

2 If necessary, select a settings category.

3 Select **≡ > Restore**.

Device Information

Specifications

Water resistance	IEC 60529 IPX7 ¹
Operating temperature range	From -20° to 55°C (from -4° to 131°F)
Charging temperature range	From 0° to 45°C (from 32° to 113°F)
Power input (CLA, motorcycle, or external power)	From 12 to 24 Vdc
Battery life	Up to 4 hr., depending on usage and settings
Battery type	Lithium-ion battery
Battery voltage range	From 3.5 to 4.1 V
Radio frequency protocol	2.4 GHz ANT+® wireless communications protocol 2.4 GHz Bluetooth wireless technology

Charging the Device

NOTE: This Class III product shall be powered by an LPS power supply.

You can charge the battery in the device using any of these methods.

- Install the device in the mount, and connect the mount to vehicle power.

NOTICE

Do not connect the device directly to the vehicle power cable.

- Connect the device to a computer using a USB cable.
The device may charge slowly when connected to a computer. Some portable computers may not charge the device.
- Connect the device to an optional power adapter accessory, such as a wall power adapter.

You can purchase an approved Garmin AC-DC adapter suitable for home or office use from a Garmin dealer or www.garmin.com.

Device Maintenance

Device Care

NOTICE

Avoid dropping your device.

Do not store the device where prolonged exposure to extreme temperatures can occur, because it can cause permanent damage.

Never use a hard or sharp object to operate the touchscreen, or damage may result.

Cleaning the Outer Casing

NOTICE

Avoid chemical cleaners and solvents that can damage plastic components.

- 1 Clean the outer casing of the device (not the touchscreen) using a cloth dampened with a mild detergent solution.
- 2 Wipe the device dry.

Cleaning the Touchscreen

- 1 Use a soft, clean, lint-free cloth.

¹ The device withstands incidental exposure to water of up to 1 m for up to 30 min. For more information, go to www.garmin.com/waterrating.

- 2 If necessary, lightly dampen the cloth with water.
- 3 If using a dampened cloth, turn off the device and disconnect the device from power.
- 4 Gently wipe the screen with the cloth.

Avoiding Theft

- Remove the device and mount from sight when not in use.
- Remove the residue left on the windshield by the suction cup.
- Do not keep your unit in the glove compartment.
- Register your device at <http://my.garmin.com>.

Resetting the Device

You can reset your device if it stops functioning.

Hold the power key for 12 seconds.

Removing the Device, Mount, and Suction Cup

Removing the Device from the Mount

- 1 Press the release tab or button on the mount.
- 2 Tilt the device forward.

Removing the Mount from the Suction Cup

- 1 Turn the device mount to the right or left.
- 2 Apply pressure until the socket on the mount releases the ball on the suction cup.

Removing the Suction Cup from the Windshield

- 1 Flip the lever on the suction cup toward you.
- 2 Pull the tab on the suction cup toward you.

Changing the Fuse in the Vehicle Power Cable

NOTICE

When replacing the fuse, do not lose any of the small pieces and make sure they are put back in the proper position. The vehicle power cable does not work unless it is assembled correctly.

If your device does not charge in your vehicle, you may need to replace the fuse located at the tip of the vehicle adapter.

- 1 Rotate the end piece ① counter clockwise to unlock it.

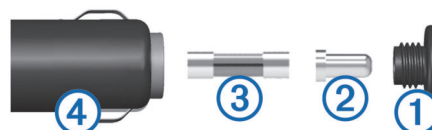

TIP: You may need to use a coin to remove the end piece.

- 2 Remove the end piece, the silver tip ②, and the fuse ③.
- 3 Insert a new fast-blow fuse that has the same current, such as 1 A or 2 A.
- 4 Place the silver tip in the end piece.
- 5 Push in the end piece and rotate it clockwise to lock it back into the vehicle power cable ④.

Troubleshooting

The suction cup will not stay on my windshield

- 1 Clean the suction cup and windshield with rubbing alcohol.
- 2 Dry with a clean, dry cloth.
- 3 Mount the suction cup (*Installation*, page 1).

My device is not acquiring satellite signals

- Verify the GPS simulator is turned off (*Navigation Settings*, page 15).
- Take your device out of parking garages and away from tall buildings and trees.
- Remain stationary for several minutes.

The device does not charge in my vehicle

- Check the fuse in the vehicle power cable (*Changing the Fuse in the Vehicle Power Cable*, page 17).
- Verify the vehicle is turned on and is supplying power to the power outlet.
- Verify the interior temperature of the vehicle is within the charging temperature range indicated in the specifications.
- Verify the fuse is not broken in the vehicle power outlet.

My battery does not stay charged for very long

- Decrease the screen brightness (*Display Settings*, page 16).
- Shorten the display timeout (*Display Settings*, page 16).
- Decrease the volume (*Adjusting the Volume*, page 4).
- Disable Bluetooth wireless technology (*Disabling Bluetooth*, page 16).
- Put the device in power saving mode when not in use (*Turning the Device On or Off*, page 3).
- Keep your device away from extreme temperatures.
- Do not leave your device in direct sunlight.

My device does not appear as a removable drive on my computer

On most Windows® computers, the device connects using Media Transfer Protocol (MTP). In MTP mode, the device appears as a portable device and not as a removable drive. MTP mode is supported by Windows 7, Windows Vista®, and Windows XP Service Pack 3 with Windows Media Player 10.

My device does not appear as a portable device on my computer

On Mac® computers and some Windows computers, the device connects using USB mass storage mode. In USB mass storage mode, the device appears as a removable drive or volume, and not as a portable device. Windows versions prior to Windows XP Service Pack 3 use USB mass storage mode.

My device does not appear as either a portable device or a removable drive or volume on my computer

- 1 Disconnect the USB cable from your computer.
- 2 Turn off the device.
- 3 Connect the USB cable to your device and to a USB port on your computer.

TIP: The USB cable must connect to a USB port on your computer, not to a USB hub.

The device turns on automatically and goes into MTP mode or USB mass storage mode. A picture of the device connected to a computer appears on the device screen.

NOTE: If you have several network drives mapped on your computer, Windows may have trouble assigning drive letters to your Garmin drives. For information about assigning drive letters, see the help file for your operating system.

My phone will not connect to the device

- Select **Settings > Bluetooth**.

The Bluetooth field must be set to Enabled.

- Enable Bluetooth wireless technology on your phone and bring your phone within 33 ft. (10 m) of the device.
- Go to www.garmin.com/bluetooth for more help.

Appendix

Installing a Memory Card for Maps and Data

You can install a memory card to increase the storage space for maps and other data on your device. You can purchase memory cards from an electronics supplier, or go to www.garmin.com/maps to purchase a memory card with pre-loaded Garmin mapping software. The device supports microSD memory cards from 4 to 32 GB.

- 1 Locate the map and data memory card slot on your device (*Device Overview*, page 3).
- 2 Insert a memory card into the slot.
- 3 Press it in until it clicks.

Data Management

You can store files on your device. The device has a memory card slot for additional data storage.

NOTE: The device is not compatible with Windows 95, 98, Me, Windows NT®, and Mac OS 10.3 and earlier.

About Memory Cards

You can purchase memory cards from an electronics supplier, or purchase pre-loaded Garmin mapping software (www.garmin.com). In addition to map and data storage, the memory card can be used to store files such as maps, images, geocaches, routes, waypoints, and custom POIs.

Connecting the Device to Your Computer

You can connect the device to your computer using a USB cable.

- 1 Plug the small end of the USB cable into the port on the device.
- 2 Plug the larger end of the USB cable into a port on your computer.

A picture of your device connected to a computer appears on the device screen.

Depending on your computer operating system, the device appears as either a portable device, a removable drive, or a removable volume.

Transferring Data From Your Computer

- 1 Connect the device to your computer (*Connecting the Device to Your Computer*, page 18).

Depending on your computer operating system, the device appears as either a portable device, a removable drive, or a removable volume.

- 2 On your computer, open the file browser.
- 3 Select a file.
- 4 Select **Edit > Copy**.
- 5 Browse to a folder on the device.

NOTE: For a removable drive or volume, you should not place files in the Garmin folder.

- 6 Select **Edit > Paste**.

Disconnecting the USB Cable

If your device is connected to your computer as a removable drive or volume, you must safely disconnect your device from your computer to avoid data loss. If your device is connected to your Windows computer as a portable device, it is not necessary to safely disconnect.

- 1 Complete an action:
 - For Windows computers, select the **Safely Remove Hardware** icon in the system tray, and select your device.
 - For Mac computers, drag the volume icon to the trash.
- 2 Disconnect the cable from your computer.

Viewing GPS Signal Status

Hold  for three seconds.

Purchasing Additional Maps

- 1 Go to your device product page at garmin.com.
- 2 Click the **Maps** tab.
- 3 Follow the on-screen instructions.

Purchasing Accessories

Go to garmin.com/accessories.

Index

Symbols

- 2-D map view **12**
- 3-D map view **12**

A

- accessories **19**
- active lane guidance **6**
- addresses, finding **9**
- answering calls **13**
- audio, proximity points **16**
- avoidances
 - area **8**
 - deleting **8**
 - disabling **8**
 - road **8**
 - road features **8**
 - tolls **7**

B

- battery
 - charging **17, 18**
 - maximizing **18**
 - problems **18**
- Bluetooth technology **12, 18**
 - disabling **16**
 - disconnecting a device **13**
 - pairing a headset **12**
 - pairing a phone **12**
 - settings **16**
- Bluetooth Technology **12**
- brightness **4**

C

- cables, motorcycle mount **1**
- calls **12, 13**
 - answering **13**
 - contacts **13**
 - dialing **12**
 - history **13**
 - home **13**
 - placing **12**
- cameras
 - red light **4**
 - speed **4**
- changing the search area **9**
- charging the device **17, 18**
- cleaning the device **17**
- cleaning the touchscreen **17**
- compass **14**
- computer, connecting **18**
- coordinates **10**
- current location **10**
- customizing the device **15**

D

- deleting
 - paired Bluetooth device **13**
 - service categories **15**
 - service records **15**
 - trips **7**
- destinations. *See* locations
- detours **6**
- device care **17**
- dialing **12**
- directions **6**
- disconnecting, Bluetooth device **13**
- display settings **16**
- driving directions **6**

E

- editing, saved trips **7**
- emergency services **10**
- EULAs **16**

F

- files, transferring **18**
- finding locations. **8, 9** *See also* locations
 - addresses **9**

- categories **9**
- cities **10**
- coordinates **10**
- intersections **10**
- Foursquare **9**
- fuel
 - stations **10**
 - tracking **8**
- fuse, changing **17**

G

- Garmin Express, updating software **3**
- geocaching **10**
- going home **5**
- GPS **3, 19**

H

- hands-free phone calls **12**
- headset **12**
 - pairing **12**
- helmet laws **5**
- help. **15** *See also* product support
- home
 - calling **13**
 - editing location **5**
 - going **5**
 - phone number **13**

I

- icons, status bar **3**
- ID number **16**
- intersections, finding **10**

K

- keyboard **4**
 - language **16**
 - layout **16**

L

- language
 - keyboard **16**
 - voice **16**
- latitude and longitude **10**
- locations **9, 15**
 - calling **13**
 - current **10**
 - recently found **10**
 - saving **10**
 - searching for **8, 9**
 - simulated **16**
 - venues **9**
- low-fuel warning **8**

M

- map layers, customizing **12**
- map view
 - 2-D **12**
 - 3-D **12**
- maps **5, 11, 15**
 - data field **5, 11, 12**
 - detail level **15**
 - layers **12**
 - purchasing **19**
 - symbols **5**
 - theme **15**
 - tools **11**
 - updating **3**
 - viewing routes **5, 6**
- media player **13**
- memory card **3, 18**
 - installing **18**
- microSD card **3, 18**
- motorcycle mount **1**
 - cables **1**
- mount, removing **17**
- mounting the device
 - automobile **2**
 - motorcycle **1**
- removing from mount **2, 17**
- suction cup **17**
- myTrends, routes **7**

N

- navigation **5, 9**
 - off-road **8**
 - settings **15**
- next turn **5**
- notifications **4, 12**

O

- off-road navigation **8**
- on-screen buttons **4**

P

- pairing
 - disconnecting **13**
 - headset **12**
 - phone **12, 18**
- parking, last spot **10**
- phone
 - disconnecting **13**
 - pairing **12, 18**
- phone book **13**
- phone calls **12**
 - answering **13**
 - dialing **13**
 - muting **13**
 - voice dial **13**
- points of interest (POI) **9**
 - venues **9**
- power cables **17**
 - changing the fuse **17**
- power key **3**
- product support **15**
- proximity points alerts, settings **16**

Q

- Quick Search **9**

R

- recently found locations **10**
- red light cameras **4**
- removing mount **17**
- resetting
 - device **17**
 - trip data **12**
- restoring settings **16**
- rider alerts **4, 15**
- routes **5**
 - adding a point **6**
 - adventurous routing **5**
 - calculating **5**
 - calculation mode **5, 7, 16**
 - myTrends **7**
 - shaping **6**
 - starting **5**
 - stopping **6**
 - suggested **7**
 - viewing on the map **5, 6**

S

- satellite signals
 - acquiring **3**
 - viewing **19**
- saved locations **7, 11**
 - categories **10**
 - deleting **11**
 - editing **10**
- saving, current location **10**
- screen, brightness **4**
- screenshots **16**
- search bar **9**
- service history
 - categories **15**
 - deleting **15**
 - editing **15**
 - records **15**
- settings **15, 16**
- shaping a route **6**
- shortcuts
 - adding **10**
 - deleting **10**
- simulated locations **16**

- sleep mode [3, 14](#)
- Smartphone Link [12](#)
- software
 - updating [3](#)
 - version [16](#)
- specifications [17](#)
- speed cameras [4](#)
- suction cup [17](#)

T

- theft, avoiding [17](#)
- time settings [16](#)
- tire pressure
 - alerts [14](#)
 - profiles [14](#)
 - sensors [14](#)
 - sleep mode [14](#)
- tolls, avoiding [7](#)
- tools, maps [11](#)
- TracBack [13](#)
- tracks [13](#)
- transportation modes [4](#)
- travel history [16](#)
- trip information [11](#)
 - resetting [12](#)
 - viewing [12](#)
- trip log, viewing [12](#)
- trip planner [6, 7](#)
 - editing a trip [7](#)
 - shaping points [7](#)
- troubleshooting [17, 18](#)
- turn list [6](#)

U

- unit ID [16](#)
- up ahead [11](#)
 - customizing [11](#)
- updating
 - maps [3](#)
 - software [3](#)
- USB, disconnecting [18](#)

V

- venues [9](#)
- VIRB remote [15](#)
- volume, adjusting [4](#)

W

- Where Am I? [10](#)

