

GARMIN®

APPROACH® R10

Portable Golf Launch Monitor

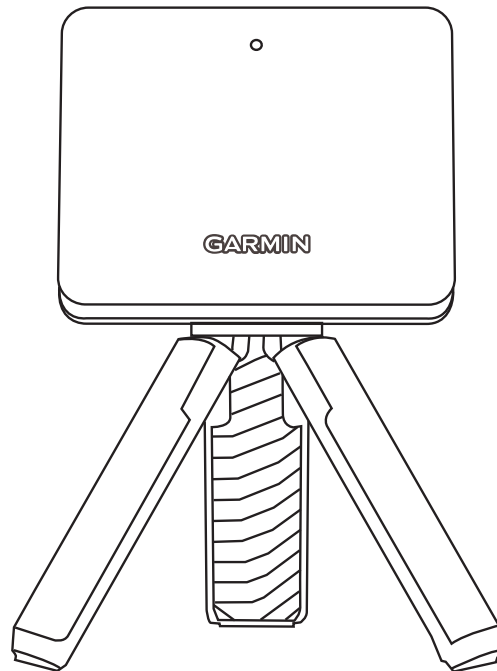

**Owner's
Manual**

Table of Contents

| | | | |
|--|-----------|---------------------------------------|----|
| Introduction..... | 3 | Getting More Information..... | 16 |
| Device Overview..... | 3 | Device Care..... | 16 |
| LED Statuses..... | 3 | Cleaning the Device..... | 16 |
| Pairing Your Smartphone..... | 4 | Long-Term Storage..... | 16 |
| Garmin Golf™ App..... | 5 | Troubleshooting..... | 16 |
| Home Tee Hero App..... | 6 | My device is tipped too far..... | 16 |
| Installing the Magnetic Tripod | | Adjusting the Device Alignment..... | 16 |
| Mount..... | 7 | Tips for Improving the Launch | |
| Preparing for a Shot..... | 8 | Monitor's Accuracy..... | 16 |
| Using the Golf Simulator Features.... | 9 | Tips for Using the Carrying Case..... | 17 |
| Setting the Weather Conditions..... | 9 | Resetting the Device..... | 17 |
| Virtual Rounds..... | 9 | My phone will not connect to the | |
| Virtual Round Scoring..... | 10 | device..... | 17 |
| Viewing Your Scorecard..... | 10 | | |
| Picking Up Your Ball..... | 10 | | |
| Ending the Round..... | 10 | | |
| On Course Practice..... | 10 | | |
| Driving Range Mode..... | 11 | | |
| Swing Capture..... | 11 | | |
| Viewing Your Driving Range | | | |
| Session Statistics..... | 12 | | |
| Editing a Shot..... | 12 | | |
| Viewing Advanced Swing Metrics... | 12 | | |
| Ending Your Driving Range | | | |
| Session..... | 12 | | |
| Viewing Saved Golf Simulator | | | |
| Sessions..... | 12 | | |
| Deleting a Saved Golf Simulator | | | |
| Session..... | 12 | | |
| Weekly Tournament..... | 12 | | |
| Connecting to a Third-Party | | | |
| Simulator..... | 13 | | |
| Appendix..... | 14 | | |
| Charging the Device..... | 14 | | |
| Viewing Battery Power..... | 14 | | |
| Using the Phone Mount..... | 14 | | |
| Product Updates..... | 15 | | |
| Setting Up Garmin Express™ | 15 | | |
| Specifications..... | 15 | | |

Introduction

⚠ WARNING

See the *Important Safety and Product Information* guide in the product box for product warnings and other important information.

Device Overview

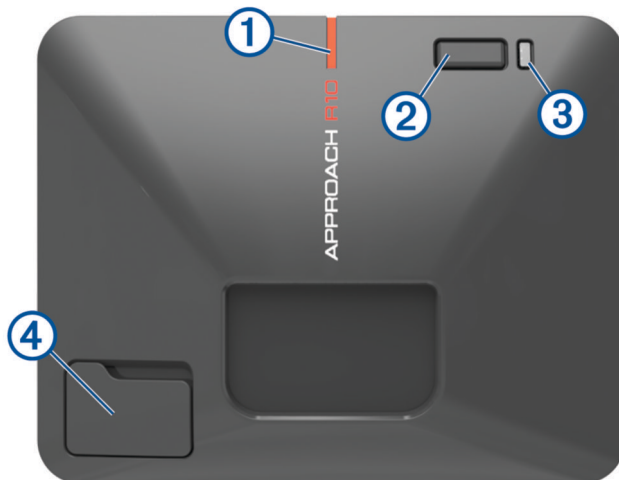

- ① **Alignment line:** Align with the ball and shot target to set the target line.
- ② **Button:** Press to turn the device on.
Hold for one second to turn the device off.
With the device turned off, hold until the status LED turns blue to enter pairing mode.
- ③ **Charge LED:** Indicates the battery status ([LED Statuses, page 3](#)).
- ④ **USB port (under weather cap):** Connect the USB cable to charge the device or download software updates using your computer.

LED Statuses

The status LED ① indicates the device status. The charge LED ② indicates the battery status.



| ① Status LED Activity | Status |
|-----------------------|---|
| Solid blue | The launch monitor is in pairing mode. |
| Flashing blue | The launch monitor is reconnecting to the previously connected phone. |
| Solid white | The launch monitor is in mass storage mode. |
| Flashing white | The launch monitor is in standby mode. |
| Flashing green | The launch monitor is ready for a shot. |
| Solid red | The launch monitor is busy. |

| ① Status LED Activity | Status |
|-----------------------|--|
| Flashing red | An error occurred. To resolve the error, reset the launch monitor. If that does not resolve the issue, go to support.garmin.com . |
| Flashing purple | A software update is in progress. |

| ② Charge LED Activity | Status |
|-----------------------|---|
| Flashing red | The battery is charging. |
| Solid red | The battery is fully charged. |
| Rapidly flashing red | The launch monitor is unplugged and the remaining battery power is low. NOTE: The LED flashes rapidly for five seconds after the launch monitor is turned on if the battery is low. |

Pairing Your Smartphone

To use this device, you must pair it with the Garmin Golf™ app.

- 1 From the app store on your smartphone, install and open the Garmin Golf app.
- 2 Bring your smartphone near your device.
- 3 Press the button to turn on your device.

The first time you turn on the device, it automatically enters pairing mode, and the status LED is solid blue.

TIP: You can hold the button while the device is off until the status LED turns solid blue to manually enter pairing mode.

- 4 From the Garmin Golf app, select **Profile > My Devices > Add Device**, and follow the on-screen instructions.

Garmin Golf™ App

The Garmin Golf app allows you to view detailed statistics and shot analyses that are recorded on your Approach® launch monitor. For viewing on a larger display, you can mirror the Garmin Golf app to a compatible smart TV using the screen mirroring function on your phone.

The Garmin Golf app syncs your data with your Garmin Connect™ account. You can download the Garmin Golf app from the app store on your phone.

Home Tee Hero App

With a Garmin Golf™ subscription, golfers can compete with each other at virtual courses and participate in a weekly virtual tournament in the Home Tee Hero app. The Home Tee Hero app connects to your Approach® launch monitor and allows you to practice or play a virtual round of golf at a course rendered with 3D technology. There are over 43,000 courses available. You can view details of previously recorded golf simulator rounds, including your position on the leaderboard for weekly simulated tournament rounds.

The Garmin Golf subscription can be purchased through either the Home Tee Hero app or the Garmin Golf app ([Garmin Golf™ App, page 5](#)). You can download the Home Tee Hero app through the app store on your phone.

Installing the Magnetic Tripod Mount

WARNING

The product contains magnets that may interfere with medical devices. Consult your physician and medical device manufacturer with questions.

NOTICE

The mount contains a magnet. Under certain circumstances, magnets may cause damage to some electronic devices, including hard drives in laptop computers. Use caution when the mount is near electronic devices.

- 1 Ensure the tripod mount is free of any debris.
- 2 Insert the top of the tripod mount into the back of the device.
The tripod mount is magnetic and holds the device in place.

NOTE: The tripod mount can only be installed one way. If it is not fully seated in the back of the device, you have installed it using the wrong orientation.



- 3 Open the tripod legs so they are fully extended.



Preparing for a Shot

⚠ CAUTION

Failing to take one or more of the following actions could result in possible property damage or personal injury while using the device indoors:

- Ensure there is adequate ceiling height and that no objects can obstruct your backswing or follow through.
- Ensure that any net or impact screen is set up with adequate free space behind the net or screen.
- Ensure that any net or impact screen is high enough and extended enough to account for high-lofted shots or any errant shots.
- Ensure that any net or enclosure frame is padded to help reduce ball ricochet.

1 Place the ball at the desired tee location.

NOTE: The tee location must be at least 8 ft. (2.4 m) away from the net when playing indoors.

2 Attach the launch monitor to the tripod mount (*Installing the Magnetic Tripod Mount, page 7*).

3 Place the launch monitor on the ground between 6 ft. and 8 ft. (1.8 m and 2.4 m) behind the tee location.

NOTE: If you are using a golf mat, make sure the bottom edge of the launch monitor sits above the mat.

4 Adjust the launch monitor so the red alignment line is aligned with the tee location and the target of the shot.

TIP: You can lay a golf club on the ground between the alignment line and tee location to confirm they are lined up.

5 If necessary, you can move the tee location up to 1 ft. (0.3 m) on either side of the target line, within a 2 x 2 ft. (0.6 x 0.6 m) hitting area that begins 6 ft. (1.8 m) from the launch monitor.

This may be helpful if your tee location becomes worn during a golf simulator game mode session.

NOTE: The ball and club angles are measured parallel to the target line.

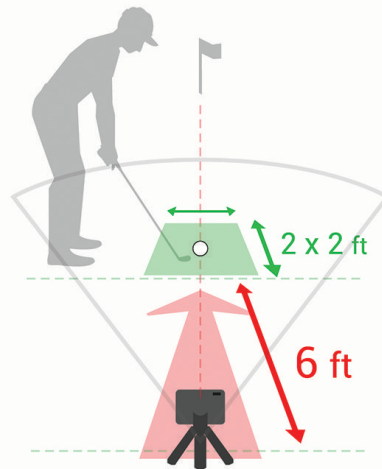

6 Press the button to turn on the launch monitor.

7 Start a golf simulator game mode (*Using the Golf Simulator Features, page 9*).

8 Wait for the status LED to begin flashing green, and take a shot.

Using the Golf Simulator Features

You can use the golf simulator features in the Garmin Golf™ and Home Tee Hero apps to test your skills and help you have fun on the driving range. These features use the internal device radar to take measurements that help you analyze your practice.

- 1 Select an option:
 - In the Home Tee Hero app, select an option from the home screen.
 - In the Garmin Golf app, select , and select an option.
- 2 Follow the on-screen instructions.

Setting the Weather Conditions

You can set weather conditions when you start a golf simulator game mode. It is important to set weather conditions that match where you typically play. If they do not match the conditions at your normal course locations, the carry distances may seem inaccurate.

- 1 Start a Home Tee Hero or Driving Range session ([Using the Golf Simulator Features, page 9](#)).
- 2 When prompted, select **Weather Conditions**.
- 3 Select an option:
 - To set the weather conditions based on the course location, select **Course Location**.
NOTE: This option is only available in the Home Tee Hero mode.
 - To set the weather conditions based on your current location, select **Your Location**.
To use the **Your Location** option, enable phone app permissions to share your location to the Garmin Golf™ app.
 - To set custom weather conditions, select **Custom**, and adjust the listed weather conditions.

Virtual Rounds

The Home Tee Hero app allows you to play a virtual round of golf at a course rendered with 3D technology. There are over 43,000 courses available ([Home Tee Hero App, page 6](#)).

In the Home Tee Hero app, select **Play**, select a course, and follow the on-screen instructions to start a virtual round.



| | |
|---|--|
| ① | The profile name for the current player. |
| ② | The current player's score for the round. |
| ③ | The hole number. |
| ④ | The shot number for the current hole. |
| ⑤ | The distance to the front and back of the green, and to the pin. |
| ⑥ | The wind speed and direction. |

| | |
|----|--|
| 7 | The direction of the pin. |
| 8 | The distance to the shot target. TIP: You can move the shot target by dragging it to the desired location on the course. |
| 9 | The elevation difference between the location of the ball and the shot target. |
| 10 | Opens the menu. |
| 11 | Changes to an overhead camera view. |

Virtual Round Scoring

During a virtual round, the Home Tee Hero app calculates your score using a method similar to stroke play. Each shot you take counts as one stroke. Hitting the ball into the water or out of bounds adds a penalty stroke. Because there is no putting in a virtual round, additional strokes are added based on how accurate you are with your approach shot. You can receive 0 to 3 additional strokes depending on how close your approach shot is to the hole.

Viewing Your Scorecard

During a virtual round, select  > **Scorecard**.

Picking Up Your Ball

During a virtual round, you can receive a score of 10 on the current hole and skip to the next hole.

Select  > **Pick Up Ball** > **Pick Up Ball**.

Ending the Round

During a virtual round, select  > **End Round**.

On Course Practice

The on course practice mode allows you to practice on over 43,000 courses rendered with 3D technology. In the Home Tee Hero app, select **Practice**, select a course, and follow the on-screen instructions to start a practice session.

NOTE: Data from on course practice sessions is not saved.



| | |
|---|--|
| 1 | Swing metrics for the most recent shot. |
| 2 | The distance to the front and back of the green, and to the pin. |
| 3 | The wind speed and direction. |
| 4 | The direction of the pin. |
| 5 | The distance to the shot target. TIP: You can move the shot target by dragging it to the desired location on the course. |

| | |
|---|--|
| ⑥ | The elevation difference between the location of the ball and the shot target. |
| ⑦ | Opens the menu. |
| ⑧ | Changes the shot location. |
| ⑨ | Changes the hole. |
| ⑩ | Changes to an overhead camera view. |

Driving Range Mode

The Driving Range mode allows you to practice on a virtual driving range, and provides detailed metrics for every shot.

In the Garmin Golf™ app, select  > **Practice** > **Start Training**, select a driving range course, and follow the on-screen instructions to start a driving range session.

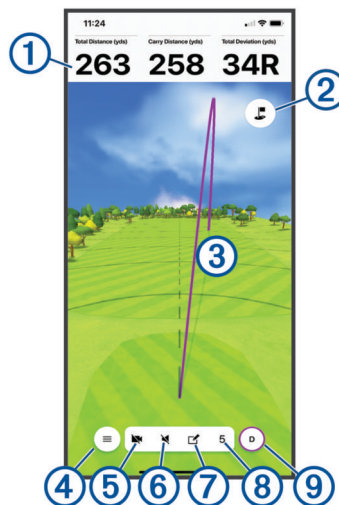

| | |
|---|--|
| ① | Displays swing metrics for the selected shot. TIP: You can change the swing metrics that are displayed by selecting the swing metric fields. |
| ② | Select to toggle to an overhead camera view with distance markers. |
| ③ | Displays the trajectory of the shot. |
| ④ | Select to open the menu. |
| ⑤ | Select to enable the Swing Capture feature. |
| ⑥ | Select to enable spoken audio metrics and to choose the metric that is spoken after each shot. |
| ⑦ | Select to tag the shot and write a note about it. |
| ⑧ | Displays the shot number. |
| ⑨ | Displays the club for the shot. |

Swing Capture



The Swing Capture feature allows you to use your paired smartphone's camera to automatically record videos of your swings during a Driving Range session. You can view the recorded swings and associate them with the advanced swing metrics recorded for that shot.

Enabling the Swing Capture Feature

Before you can enable the Swing Capture feature, you must allow the Garmin Golf™ app to use the camera on your paired smartphone.

- 1 During a Driving Range session, select .
- 2 Select the **Swing Capture** toggle switch.

Viewing Your Recorded Swings

- 1 During a Driving Range session, select  > **Session Stats**.
- 2 Swipe up from the bottom of the screen.
- 3 Select a recorded shot from the shot list.
- 4 If necessary, select  > **Swing Playback**.

Viewing Your Driving Range Session Statistics

- 1 During a Driving Range session, select  > **Session Stats**.
- 2 Swipe up from the bottom of the screen.
Statistics for each shot and club appear.

TIP: You can filter out a club from the club and shot lists by selecting the club at the top of the screen.



Editing a Shot

You can edit a previous shot.

- 1 During a Driving Range session, select  > **Session Stats**.
- 2 Swipe up from the bottom of the screen.
- 3 Select **Edit**.
- 4 Select a shot.
- 5 Select an option:
 - To change the club for the shot, select **CHANGE CLUB**, and select a club.
 - To delete the shot, select **DELETE**.
- 6 Select **Save**.

Viewing Advanced Swing Metrics

You can view advanced swing metrics for any shot from a Driving Range session.

- 1 During a Driving Range session, select  > **Session Stats**.
- 2 Swipe up from the bottom of the screen.
- 3 Select a shot from the shot list.
- 4 Select  > **Ball Impact** or  > **Data Fields**.

Viewing Swing Metric Descriptions

During a Driving Range session, hold your finger on a swing metric field for one second.
A description and illustration of the swing metric appears.

Ending Your Driving Range Session

- 1 During a Driving Range session, select  > **End Session**.
- 2 Select an option:
 - To save the session, select **Save**.
 - To delete the session, select **Delete**.

Viewing Saved Golf Simulator Sessions

You can view all of your saved golf simulator sessions in the Garmin Golf™ app.

- 1 In the Garmin Golf app, select **Activity**.
- 2 Select a session.

Deleting a Saved Golf Simulator Session

- 1 In the Garmin Golf™ app, select **Activity**.
- 2 Select a session.
- 3 Select **•••** > **Delete**.

Weekly Tournament

With a Garmin Golf™ membership, you can compete in a virtual tournament against other golfers around the world on different courses each week. You can play in each weekly tournament as many times as you want. All scores are posted on the leaderboard.

Connecting to a Third-Party Simulator

You can view all of your recorded shots in detailed, high-definition graphics on your compatible third-party simulator software.

- 1 In the Garmin Golf™ app, select  > **Other Simulators**.
- 2 Select a simulator app.
- 3 Follow the on-screen instructions.

Appendix

Charging the Device

⚠ WARNING

This product contains a lithium-ion battery. To prevent the possibility of personal injury, product damage, or other property damage caused by battery exposure to extreme heat, store the device out of direct sunlight.

NOTICE

To prevent corrosion, thoroughly dry the USB port, the weather cap, and the surrounding area before charging or connecting to a computer.

The device is powered by a built-in lithium-ion battery that you can charge using a standard wall outlet or a USB port on your computer. You can use the device radar features while the device is charging.

NOTE: The device will not charge when outside the approved temperature range (*Specifications, page 15*).

- 1 Pull up the weather cap from the USB port.
- 2 Plug the small end of the USB cable into the USB port on the device.
- 3 Plug the large end of the USB cable into an external power source, such as an AC adapter or a USB port on your computer.
- 4 Charge the device completely.

TIP: You can turn off the device or connect it to an AC adapter to charge it faster.

Viewing Battery Power

You can view the remaining battery power of the device when it is connected to the Garmin Golf™ app.

- 1 From the ☰ or ●●● menu in the app, select **Garmin Devices**.
- 2 Select your device.

NOTE: A message appears when the remaining battery power is below 10%.

Viewing Battery Power During a Golf Simulator Session

You can view the remaining battery power of the device during a golf simulator session.

In the Garmin Golf™ app, select ●●● or ☰.

A battery gauge appears in the menu.

Using the Phone Mount

You can use the phone mount and bag clip to attach your paired smartphone to your golf bag for convenient viewing and interaction with the Garmin Golf™ app. The phone mount is compatible with smartphones in portrait view with widths between 58 mm (2.3 in.) and 90 mm (3.5 in.). The phone mount should only be attached when your golf bag is stationary.

- 1 Insert the bag clip ball mount into the back of the phone mount until it clicks into place.



- 2 Pull the adjustable side of the phone mount outward.
- 3 Position your smartphone within the phone mount.



4 Release the adjustable side of the phone mount to secure your smartphone in place.

5 Clip the bag clip to the top of your golf bag.

NOTE: Your smartphone should sit below the top of the bag to avoid making contact with your golf clubs.



Product Updates

On your computer, install Garmin Express (www.garmin.com/express). On your smartphone, install the Garmin Golf™ app.

This provides easy access to these services for Garmin® devices:

- Software updates
- Product registration

Setting Up Garmin Express™

- 1 Connect the device to your computer using a USB cable.
- 2 Go to www.garmin.com/express.
- 3 Follow the on-screen instructions.

Specifications

| | |
|-----------------------------|--|
| Battery type | Rechargeable, built-in lithium-ion battery |
| Battery life | Up to 10 hr. |
| Operating temperature range | From -10° to 55°C (from 14° to 131°F) |
| Charging temperature range | From 0° to 45°C (from 32° to 113°F) |

| | |
|--------------------------------|--|
| Wireless frequencies/protocols | 2.4 GHz @ 6.2 dBm maximum 24 GHz @ 20 dBm maximum |
| Water rating | IEC 60529 IPX7 ¹ |

Getting More Information

You can find more information about this product on the Garmin® website.

- Go to support.garmin.com for additional manuals, articles, and software updates.
- Go to buy.garmin.com, or contact your Garmin dealer for information about optional accessories and replacement parts.

Device Care

NOTICE

Avoid extreme shock and harsh treatment, because it can degrade the life of the product.

Do not use a sharp object to clean the device.

Avoid chemical cleaners, solvents, and insect repellents that can damage plastic components and finishes.

Do not store the device where prolonged exposure to extreme temperatures can occur, because it can cause permanent damage.

Secure the weather cap tightly to prevent damage to the USB port.

Cleaning the Device

- 1 Clean the surface of the device using a cloth dampened with a mild detergent solution.
- 2 Wipe the device dry.

Long-Term Storage

When you do not plan to use the device for several months, you should charge the battery to at least 50% before you store the device. You should store the device in a cool, dry place with temperatures around the typical household level. After storage, you should fully recharge the device before using it.

Troubleshooting

My device is tipped too far

If an error message appears in the Garmin Golf™ app indicating your device is tipped too far, you can try these tips.

- Verify the tripod mount is properly installed on the device.
- Move the device to a more level surface.
- Move the device to a more stable surface.
- Move the device to a surface that is more in line with the ball.

Adjusting the Device Alignment

If the device is misaligned, your swing metrics while using the golf simulator features will not be accurate. For example, if the alignment is off by several degrees, the metrics will also be off by several degrees. If your swing metrics seem to be inaccurate, you can adjust the alignment.

- 1 Hit a short, straight shot using a high loft club, such as a sand wedge.
- 2 Compare the shot to the ball launch direction in the Garmin Golf™ app.
If the device is misaligned, the ball launch direction in the app will not match your shot. For example, if the device is facing too far to the left of your target line, the launch direction shown in the app will be farther right than your shot.
- 3 Adjust the alignment of the device as needed.
- 4 Repeat this process until the ball launch direction in the app matches your shot.

Tips for Improving the Launch Monitor's Accuracy

If your swing metrics seem to be inaccurate, you can try these tips.

- When prompted after starting a golf simulator game mode, set the exact distance between the launch monitor and the tee location.

¹ The device withstands incidental exposure to water of up to 1 m for up to 30 min. For more information, go to www.garmin.com/waterrating.

- When prompted after starting a golf simulator game mode, set weather conditions that match where you typically play ([Setting the Weather Conditions, page 9](#)).
- Adjust the alignment of the launch monitor ([Adjusting the Device Alignment, page 16](#)).

Tips for Using the Carrying Case

- Place the device in the carrying case with its front facing down to avoid pressing the button.
- Leave the bag clip and phone mount attached when placing them in the carrying case.

Resetting the Device

If the device stops responding, you may need to reset it. This does not erase any of your data.

Hold the button until the status LED turns off.

The device resets.

My phone will not connect to the device

If your phone will not connect to the device, you can try these tips.

- Bring the device within range of your phone.
- Turn off your phone and your device, and turn them back on again.
- Make sure Bluetooth® technology is enabled on your phone.
- Make sure the status LED on the device is flashing blue.
- Update the Garmin Golf™ app to the latest version.
- Update the Home Tee Hero app to the latest version.
- If your device is already paired to your phone, turn Bluetooth technology off on your phone, and turn it back on.
- Remove your device from the Garmin Golf app and the Bluetooth settings on your phone to retry the pairing process.
- If you bought a new phone, remove your device from the Garmin Golf app on the phone you intend to stop using.
- On your phone, open the Garmin Golf app, and select **Profile > My Devices > Add Device** to enter pairing mode.
- With your device turned off, hold the button until the status LED turns solid blue to enter pairing mode.

support.garmin.com

© 2021 Garmin Ltd. or its subsidiaries

Garmin®, the Garmin logo, and Approach® are trademarks of Garmin Ltd. or its subsidiaries, registered in the USA and other countries. Garmin Connect™, Garmin Express™, and Garmin Golf™ are trademarks of Garmin Ltd. or its subsidiaries. These trademarks may not be used without the express permission of Garmin.

The Bluetooth® word mark and logos are owned by Bluetooth SIG, Inc. and any use of such marks by Garmin is under license. Other trademarks and trade names are those of their respective owners.