

VARIA™ REARVIEW RADAR RVR315

Owner's Manual

© 2020 Garmin Ltd. or its subsidiaries

All rights reserved. Under the copyright laws, this manual may not be copied, in whole or in part, without the written consent of Garmin. Garmin reserves the right to change or improve its products and to make changes in the content of this manual without obligation to notify any person or organization of such changes or improvements. Go to www.garmin.com for current updates and supplemental information concerning the use of this product.

Garmin®, the Garmin logo, ANT+®, Edge®, fēnix®, Forerunner®, and vívoactive® are trademarks of Garmin Ltd. or its subsidiaries, registered in the USA and other countries. Garmin Connect™, Garmin Express™, and Varia™ are trademarks of Garmin Ltd. or its subsidiaries. These trademarks may not be used without the express permission of Garmin.

The BLUETOOTH® word mark and logos are owned by the Bluetooth SIG, Inc. and any use of such marks by Garmin is under license.

M/N: A03749

Country restrictions apply. 010-02254-00 is approved for operation in France and the United Kingdom. 010-02253-00 is approved for operation in Germany.

Table of Contents

Introduction	1
Getting Started.....	1
Tips for Installing the Device.....	1
Installing the Universal Mount.....	1
Device Overview.....	1
Varia RVR315 Status LED.....	1
The Varia RVR315 and Your Edge 1030	1
Pairing the Varia Radar Device with Your Edge 1030.....	1
Viewing Radar on Your Edge Device.....	2
Tone Alerts for Approaching Vehicles.....	2
Viewing Edge Widgets.....	2
Customizing the Radar Alert Settings with Your Edge 1030.....	2
The Varia RVR315 and the Varia App	2
Pairing the Varia Radar Device with Your Smartphone.....	2
Viewing Radar on the Varia App.....	2
Customizing the Varia App Alert Settings.....	3
The Varia RVR315 and Your Radar Display Unit	3
Varia RDU Device Overview.....	3
Installing the Varia RDU Device.....	3
Pairing the Radar Device with the RDU Device.....	3
Turning On the Varia RDU Device.....	3
Turning Off the Varia RDU Device and Radar Device.....	4
Other Compatible Devices	4
Pairing the Radar Device with a Compatible Edge Device.....	4
Pairing the Radar Device with a Compatible Garmin Watch.....	4
Device Information	4
Charging the Device.....	4
Device Care.....	4
Radar Detection.....	4
Specifications.....	5
Troubleshooting	5
Resetting the Device.....	5
Updating the Radar Software With Your Edge Device.....	5
Product Updates.....	5
The radar device is not responding.....	5
Radar detection does not work indoors.....	5
The radar device does not turn on.....	5
The status LED is flashing yellow.....	5
The status LED turns red while charging.....	5
The status LED turns red while updating the software.....	5
The radar device disconnects from the Edge device.....	5
The radar device disconnects from the Varia app.....	6
The radar device disconnects from the Varia RDU device.....	6
Replacement O-rings.....	6
Getting More Information.....	6
Index	7

Introduction

⚠ WARNING

See the *Important Safety and Product Information* guide in the product box for product warnings and other important information.

The device can improve situational awareness. It is not a replacement for cyclist attentiveness and good judgement. Always use your best judgment, and operate the bicycle in a safe manner. Failure to do so could result in serious injury or death.

Always consult your physician before you begin or modify any exercise program.

Getting Started

You can use the Varia Rearview Radar RVR315 with your compatible Garmin® device, a smartphone, or the Varia RDU (radar display unit). This list provides an overview of the installation and setup tasks.

- Charge the device (*Charging the Device*, page 4).
- Install the universal mount (*Installing the Universal Mount*, page 1).
- If you are using an Edge® 1030 device, pair the devices (*The Varia RVR315 and Your Edge 1030*, page 1).
- If you are using your smartphone, download the Garmin Varia app to your smartphone, and pair the devices (*The Varia RVR315 and the Varia App*, page 2).
- If you are using the Varia RDU, pair the devices (*The Varia RVR315 and Your Radar Display Unit*, page 3).
- If you are using another Garmin device, pair the devices (*Other Compatible Devices*, page 4).

Tips for Installing the Device

The Varia Rearview Radar RVR315 device includes a micro radar that can detect approaching vehicles up to 140 meters away.

- Select a secure location to mount the device where it does not interfere with the safe operation of your bike.
- Mount the device as high on the seat post as possible for optimal radar detection.
- **NOTE:** The mount surface should be vertical. The mounts are designed to accommodate most seat post angles.
- Mount the Varia RVR315 device on the seat post 250 mm to 1200 mm above the road.
- Install the device correctly.

The device faces backward and is perpendicular to the road.

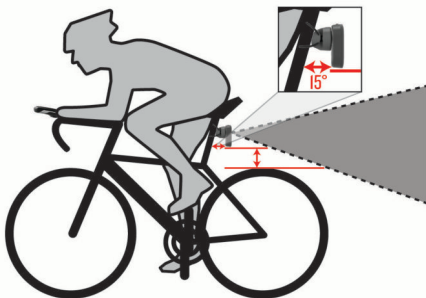

- Go for a test ride during the day in a safe environment.

Installing the Universal Mount

- 1 Select a rubber pad ① based on your seat post shape, and place the rubber pad on the back of the universal mount.
- 2 Place the universal mount on the seat post.

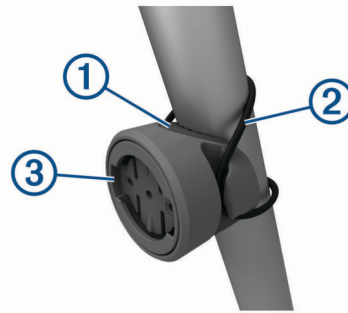

- 3 Attach the universal mount securely using one band ②.
- 4 Align the tabs on the back of the device with the universal mount notches ③.
- 5 Press down slightly and turn the device clockwise until it locks into place.

Device Overview



① Device key	Hold for 1 second to turn the device on and enter active mode. Hold for 2 seconds to turn the device off. Hold for 8 seconds to reset the device.
② Status LED	Changes color based on the battery level, pairing status, and charging status. (<i>Varia RVR315 Status LED</i> , page 1)

Varia RVR315 Status LED

LED State	Status
Flashing blue	The device is in active pairing mode. The device is connected and transferring ANT® and Bluetooth® data.
Flashing green	The device is charging.
Solid green	The device is fully charged.
Flashing red	The device has approximately 60 or fewer minutes of battery life remaining.
Solid red	An error occurred. You may need to restart the device.

The Varia RVR315 and Your Edge 1030

You can remotely control your radar device and customize settings using your compatible Edge device. This section contains instructions for the Edge 1030 device. Other compatible Edge devices contain similar settings and controls (*Other Compatible Devices*, page 4).

Pairing the Varia Radar Device with Your Edge 1030

The first time you connect the Varia RVR315 device to your Edge device, you must pair both devices. After the initial pairing, the Edge device automatically connects to the radar device.

when you start your activity and the radar device is active and within range.

NOTE: The radar device is compatible with other Garmin devices (*Other Compatible Devices*, page 4).

- 1 Bring the Edge device within range (3 m) of the sensor.
NOTE: Stay 10 m away from other ANT+® sensors while pairing.
- 2 Turn on the Edge device.
- 3 Select  > **Sensors** > **Add Sensor** > **Search All**.
- 4 While the Varia RVR315 device is turned off, hold the device key for 1 second to enter active mode.
The status LED flashes blue, and the radar device turns on.
- 5 Select your sensor, and select **Add**.

When the sensor is paired with your Edge device, the sensor status is Connected. The  (radar) status icon appears solid on the top banner of the home screen.

Viewing Radar on Your Edge Device

Go for a ride.

The radar information appears on the active data screen.

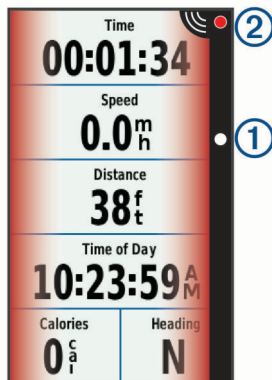

The vehicle position LED ① moves up the column as a vehicle gets closer to your bike. The threat level LED ② changes color based on the potential level of threat. Green indicates no vehicle is detected. Amber indicates a vehicle is approaching. Red indicates a vehicle is advancing at a high rate of speed.

Tone Alerts for Approaching Vehicles

The Edge device beeps if audible tones are turned on in the settings. Your device has alert tones for several features. The alert tone for approaching vehicles has a unique sound. The device beeps one time when the first vehicle is detected. After the threat is cleared, the device beeps again when another vehicle is detected.

Viewing Edge Widgets

- 1 From the home screen, swipe down from the top of the screen.
The settings widget appears. A flashing icon means the device is searching. You can select any icon to change the settings.
- 2 Swipe left or right to view more widgets.
The next time you swipe down to view the widgets, the last widget you viewed appears.

Customizing the Radar Alert Settings with Your Edge 1030

Before you can customize the radar alert settings with your Edge device, you must pair the devices.

You can customize how the radar alerts sound and display on your Edge device.

- 1 From your Edge device, select  > **Sensors**.
- 2 Select your radar device.
- 3 Select **Sensor Details** > **Alert Settings**.
- 4 Select an option.

The Varia RVR315 and the Varia App

The Varia app connects to your Varia radar device using Bluetooth technology. The app displays radar information and enables you to view settings.



- After pairing, the app displays a colored banner indicating the threat level posed by approaching vehicles.
- You can enable smartphone vibration alerts so you can monitor those alerts while your smartphone is in your pocket, instead of mounted on the handlebar.
- You can view radar device battery details.

You can download the Varia app from the app store on your smartphone.

Pairing the Varia Radar Device with Your Smartphone

The first time you connect the Varia RVR315 device to the Varia app, you must pair both devices. After the initial pairing, the Varia app automatically connects to the Varia RVR315 when you open the app and the radar device is active and within range.

- 1 Bring your smartphone within range (3 m) of the radar device.
NOTE: Stay 10 m away from other Bluetooth sensors while pairing.
- 2 On your compatible smartphone, enable Bluetooth technology.
- 3 From the app store on your smartphone, install and open the Varia app.
- 4 Select **Pair Now**.
- 5 While the Varia RVR315 radar device is turned off, hold the device key for 1 second to enter active mode.
The status LED flashes blue, and the radar device turns on. The device is in pairing mode until you press the device key.
- 6 Select **That's Mine**.

When the radar device is paired with your smartphone, the app displays the current status, , and .

Viewing Radar on the Varia App

Go for a ride.

The radar information appears on the active data screen.

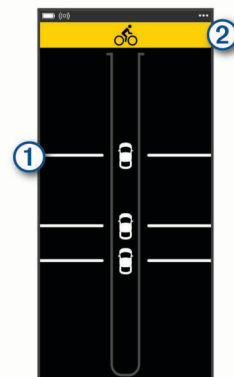

The vehicle position ① moves up the screen as a vehicle gets closer to your bike. The threat level banner ② changes

color based on the potential level of threat. Green indicates no vehicle is detected. Amber indicates a vehicle is approaching. Red indicates a vehicle is advancing at a high rate of speed.

TIP: The line next to the vehicle also indicates the threat level. A straight line changes to jagged with a red threat level.

Customizing the Varia App Alert Settings

Before you can customize the radar alert settings with the Varia app, you must pair the devices.

- 1 From the Varia app, select **••• > Settings**.
- 2 Select an option.

The Varia RVR315 and Your Radar Display Unit

You can display radar data using the compatible rear display unit (RDU).

Varia RDU Device Overview

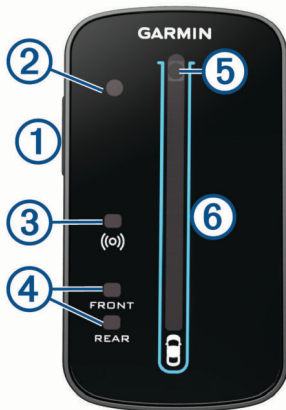

① Device key	Turns the device on and off.
② Ambient light sensor	Detects available light and automatically adjusts the brightness of the display.
③ Connection status LED	Appears solid blue when the device is paired with the radar device. Flashes blue when the device is searching for the radar device.
④ FRONT and REAR device status LEDs	Flashes red when the battery is low. Appears solid red when there is a device error.
⑤ Threat level LED Charging status LED (Charging the Device , page 4)	Changes color based on the potential level of threat. Green indicates no vehicle is detected. Amber indicates a vehicle is approaching. Red indicates a vehicle is advancing at a high rate of speed.
⑥ Vehicle position LEDs	Moves up the column as the vehicle gets closer to your bike.

Installing the Varia RDU Device

NOTE: If you do not have a Varia RDU device, you can use a compatible Edge device.

You can install the device on the stem or the handlebars.

- 1 Select a secure location to mount the device where it does not interfere with the safe operation of your bike.
- 2 Place the rubber disk ① on the back of the bike mount. The rubber tabs align with the back of the bike mount so it stays in place.

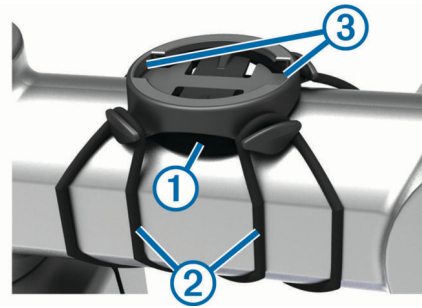

- 3 Place the bike mount on the bike stem.
- 4 Attach the bike mount securely using the two bands ②.
- 5 Align the tabs on the back of the device with the bike mount notches ③.
- 6 Press down slightly and turn the device clockwise until it locks into place.



Pairing the Radar Device with the RDU Device

The Varia RDU device can be paired with one radar device at a time.

- 1 Hold the Varia RDU device key for 5 seconds. The threat level LED flashes purple.
- 2 Turn on the radar unit.
- 3 Bring the devices within 1 cm of each other, and wait while the devices connect. The Varia RDU (⦿) LED turns solid blue and the threat level LED turns solid green. The Varia RVR315 status LED flashes blue.

Turning On the Varia RDU Device

Hold the device key for 1 second to turn on the device. The LEDs fill the column to indicate the battery level. The (⦿) LED flashes blue while it is searching for the radar device.

Varia RDU Battery Status LED

When you turn on the device, the LED at the top of the column briefly indicates the battery status.

LED Activity	Status
Flashing green	The device is charging.
Solid green	Charging is complete.
Flashing yellow	The battery is low.
Flashing red	The battery is critically low.

Setting the Varia RDU Device Tones

- Press the device key to turn on tones.
- Press the device key again to turn off tones.

Turning Off the Varia RDU Device and Radar Device

If the Varia RDU device is paired with the radar device, you can turn off both devices at the same time.

Hold the device key on the Varia RDU device for 1 second.

Other Compatible Devices

Pairing the Radar Device with a Compatible Edge Device

This task is for the Edge 1000, 830, 530, and 130 devices. If your device is not listed, go to buy.garmin.com.

- 1 Bring the Edge device within range (3 m) of the sensor.
NOTE: Stay 10 m away from other ANT+ sensors while pairing.
- 2 Turn on the Edge device.
- 3 From the **Sensors** menu, select **Add Sensor > Search All**.
- 4 While the Varia RVR315 device is turned off, hold the device key for 1 second to enter active mode.

The status LED flashes blue, and the radar device turns on.

- 5 Select your sensor.

When the sensor is paired with your Edge device, the radar status icon appears solid.

Pairing the Radar Device with a Compatible Garmin Watch

This task is for the Forerunner® 945, fēnix® 6 series, and vívoactive® 4 series watches. If your device is not listed, go to buy.garmin.com.

- 1 Bring the watch within range (3 m) of the sensor.
NOTE: Stay 10 m away from other ANT+ sensors while pairing.
- 2 Turn on the Garmin watch.
- 3 From the **Settings** menu, select **Sensors > Add New > Search All**.
- 4 While the Varia RVR315 device is turned off, hold the device key for 1 second to enter active mode.

The status LED flashes blue, and the radar device turns on.

- 5 Select your sensor.

When the sensor is paired with your Garmin watch, the radar status icon appears solid.

Device Information

Charging the Device

NOTICE

To prevent corrosion, thoroughly dry the USB port, the weather cap, and the surrounding area before charging or connecting to a computer.

The device is powered by a built-in lithium-ion battery that you can charge using a standard wall outlet or a USB port on your computer.

NOTE: The device does not charge when outside the approved temperature range (*Varia RVR315 Specifications, page 5*).

- 1 Pull up the weather cap ① from the USB port ②.



- 2 Plug the small end of the USB cable into the USB port on the device.
- 3 Plug the large end of the USB cable into an AC adapter or a computer USB port.
- 4 Plug the AC adapter into a standard wall outlet.
- 5 Charge the device completely.
The status LED flashes green while charging. The status LED is solid green when charging is complete.
- 6 Remove the USB cable, and close the weather cap.

Tips for Charging the Device

- Connect the charger securely to the device.
You can charge the device by plugging the USB cable into a Garmin approved AC adapter with a standard wall outlet or a USB port on your computer. Charging a fully depleted battery takes about 5 hours using a computer and 3 hours using an AC power source.
- Remove the charger from the device when the status LED is solid green.
- View the remaining battery life  on your Edge 1030 settings widget (*Viewing Edge Widgets, page 2*).

Device Care

NOTICE

Do not store the device where prolonged exposure to extreme temperatures can occur, because it can cause permanent damage.

Avoid chemical cleaners, solvents, and insect repellents that can damage plastic components and finishes.

Secure the weather cap tightly to prevent damage to the USB port.

Avoid extreme shock and harsh treatment, because it can degrade the life of the product.

Cleaning the Device

- Clear mud and dirt from the weather cap area.
- While the weather cap is closed, hold the device under running water.

After cleaning, allow the device to dry completely.

Radar Detection

- The radar detects approaching vehicles up to 140 m away.
- The approaching vehicle speed must be from 10 to 160 km/h (from 6 to 99 mph).

NOTE: The radar does not detect vehicles traveling at the same speed as your bike.

- The radar beam width is 40 degrees. It provides radar coverage for typical bends in the road.
- The radar can detect up to eight approaching vehicles.

Specifications

Varia RVR315 Specifications

Battery type	Rechargeable, built-in lithium-ion battery
Battery life	Up to 7 hr. in active mode
Operating temperature range	From -20° to 50°C (from -4° to 122°F)
Charging temperature range	From 0° to 40°C (from 32° to 104°F)
Wireless frequency	2.4 GHz @ 4 dBm nominal; 2.4 GHz @ 12 dBm nominal
Water rating	IEC 60529 IPX7 ¹

Varia RDU Specifications

Battery type	Rechargeable, built-in lithium-ion battery
Battery life	Up to 10 hr., typical usage
Operating temperature range	From -20° to 60°C (from -4° to 140°F)
Charging temperature range	From 0° to 45°C (from 32° to 113°F)
Wireless frequency	2.4 GHz ANT+ @ 4 dBm nominal
Water rating	IEC 60529 IPX7 ¹

Troubleshooting

Resetting the Device

You can reset the device if it stops responding.

Hold the device key for 8 seconds until all the LEDs turn off.

Resetting deletes the pairing connections from the device.

Updating the Radar Software With Your Edge Device

Before you can update the Varia radar software, you must pair the radar device with your Edge device, you must have a Garmin Connect™ account, and you must pair the Edge device with a compatible smartphone.

- 1 Bring the Edge device within 3 m (10 ft.) of the radar device.
- 2 Sync your Edge device with the Garmin Connect app.
When new software is available, your device alerts you to update the software.
- 3 Follow the on-screen instructions.

The radar device LED flashes blue and green to indicate the device is updating. When the update is complete, the LED flashes green 20 times.

Product Updates

On your computer, install Garmin Express™ (www.garmin.com/express).

This provides easy access to these services for Garmin devices:

- Software updates
- Product registration

Updating the Software Using the Garmin Express Application

Before you can update your device software, you must download the Garmin Express application.

- 1 Connect the radar device to your computer using the USB cable.

Garmin Express looks for software updates automatically and sends them to your device.

- 2 Follow the on-screen instructions.

- 3 Disconnect the device, and turn it on.

The radar LED flashes blue and green to indicate the device is updating. When the update is complete, the LED flashes green 20 times.

The radar device is not responding

During a ride, if the radar device status LED is solid red, the device is in an error state.

- Make sure the device is within the approved operating temperature range (*Varia RVR315 Specifications, page 5*).
- Turn the device off, and turn it back on.

You can check the battery level on the **Sensors** menu of your Edge device or on the Varia app.

- Avoid multiple sources of radar interference.

Radar detection does not work indoors

The device is tuned to detect vehicles in an outdoor setting. If you turn on the device indoors, a saturation alert can occur. When you take the device outdoors, the device resumes normal operation.

The radar device does not turn on

- Make sure the device is within the approved operating or charging temperature range (*Varia RVR315 Specifications, page 5*).
- Charge the device for 4 hours (*Charging the Device, page 4*).
If the device does not turn on, disconnect the charger, and charge for another 4 hours.

The status LED is flashing yellow

If the radar device status LED flashes yellow, the device is in demo mode. When the radar device is in demo mode, artificial data is generated for demonstration only.

To exit demo mode, select an option:

- Turn the device off, and turn it back on.
- Hold the device key for 8 seconds to reset the device.

The status LED turns red while charging

- Check the USB cable, connectors, and ports for damage.
- Make sure the power source is generating power.

You can check this several ways. For example, you can check whether other devices powered by the source are functioning.

- Make sure the device is within the approved charging temperature range (*Varia RVR315 Specifications, page 5*).

The status LED turns red while updating the software

- Check the USB cable, connectors, and ports for damage.
- Turn both devices off, and turn them back on.
- Make sure the device is within the approved operating temperature range (*Varia RVR315 Specifications, page 5*).

The radar device disconnects from the Edge device

WARNING

If the radar device is not connected or sending radar data, Garmin recommends that you stop riding and check the devices

¹ The device withstands incidental exposure to water of up to 1 m for up to 30 min. For more information, go to www.garmin.com/waterrating.

in a safe location. Failure to do so could result in serious injury or death.

- Turn both devices off, and turn them back on.
- Pair the devices (*Pairing the Varia Radar Device with Your Edge 1030, page 1*).

The Varia RVR315 device sends radar data to the Edge device. The Edge device displays  when connected.

The radar device disconnects from the Varia app

WARNING

If the radar device is not connected or sending radar data, Garmin recommends that you stop riding and check the devices in a safe location. Failure to do so could result in serious injury or death.

- Turn off Bluetooth technology from your smartphone settings, and turn it back on.
- Turn both devices off, and turn them back on.
The Varia RVR315 device sends radar data to the Varia app. The Varia app displays  when connected.

The radar device disconnects from the Varia RDU device

WARNING

If the radar device is not connected or sending radar data, Garmin recommends that you stop riding and check the devices in a safe location. Failure to do so could result in serious injury or death.

If the threat level LED is solid red and the REAR LED is off, the radar device is not connected to the Varia RDU device.

- Turn both devices off, and turn them back on.
You can check the battery level when you turn the devices back on.
- Pair the devices (*Pairing the Radar Device with the RDU Device, page 3*).

Replacement O-rings

Replacement bands (O-rings) are available for the mounts.

NOTE: Use Ethylene Propylene Diene Monomer (EPDM) replacement bands only. Go to <http://buy.garmin.com>, or contact your Garmin dealer.

Getting More Information

- Go to support.garmin.com for additional manuals, articles, and software updates.
- Go to buy.garmin.com, or contact your Garmin dealer for information about optional accessories and replacement parts.

Index

A

accessories 6
alerts 2, 3
ANT+ sensors 2
apps 2
 smartphone 3

B

bands 6
battery 1, 3
 charging 4, 5
bike sensors 1, 2

C

charging 4
cleaning the device 4
customizing the device 1–3

D

data, screen 2
demo mode 5
device, care 4

E

Edge 1, 2, 4

F

fēnix 4
Forerunner 4

G

Garmin Express 5
 updating software 5
GPS, signal 2

I

indoor training 5
installing 1, 3

K

keys 1, 3

M

mounting the device 1, 3

O

O-rings. See bands

P

pairing 1–6
power key 1

R

radar 2
resetting, device 5

S

satellite signals 2
screen 2
settings 2, 3
smartphone 2
software, updating 5
specifications 4, 5
speed 2
status LED 1, 3

T

tones 2, 3
troubleshooting 3–6

U

updates, software 5
USB 5

V

vívoactive 4

W

Wi-Fi 2

